

# Dräger

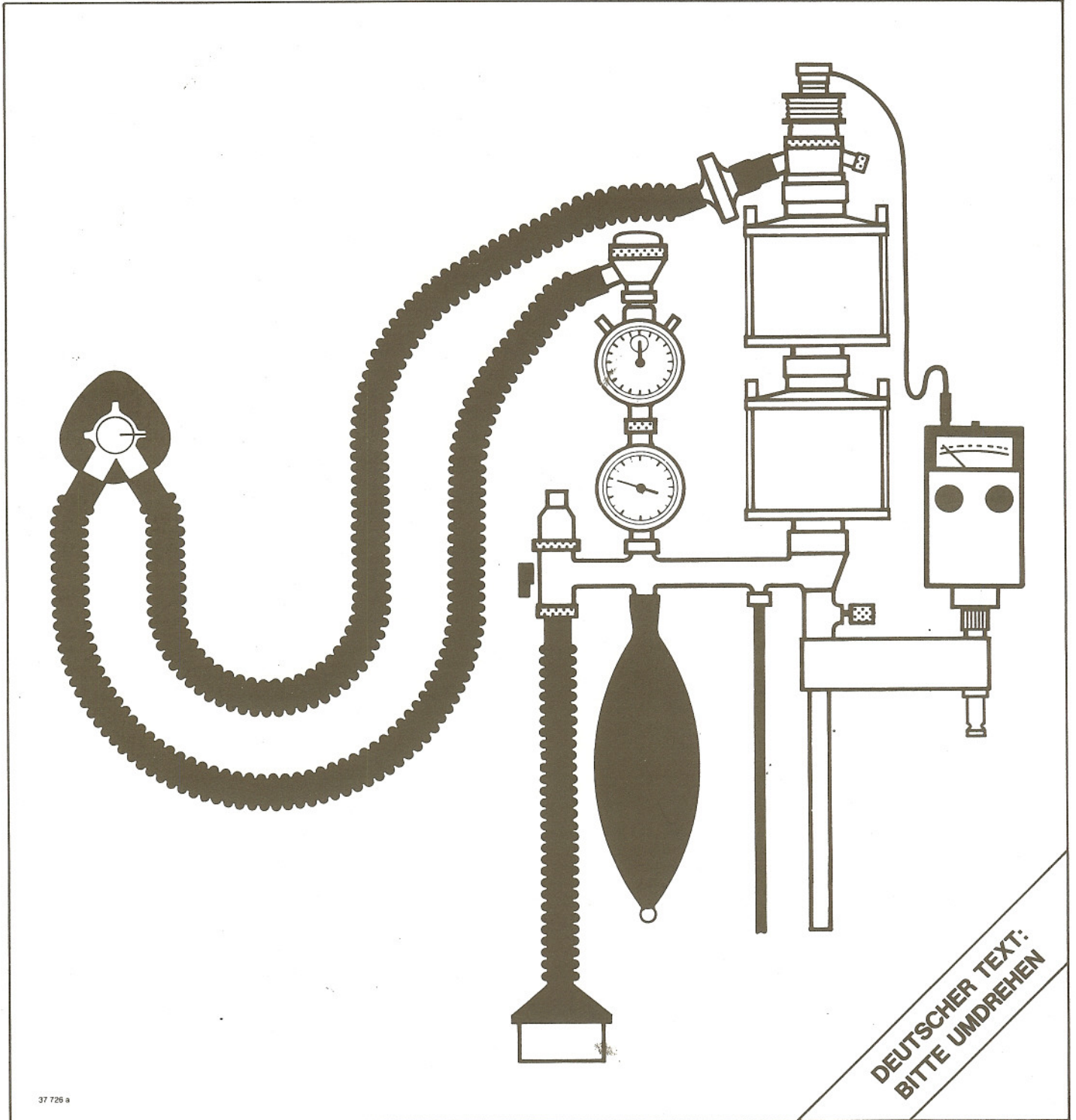

OPERATING MANUAL

## Circle Absorption System 7a (8 ISO)

# From Dräger: Circle Absorption System 7a (8 ISO)

## OPERATING INSTRUCTIONS

### Important Notice

For correct and effective use of the appliance, and to avoid hazards, we would point out the following:

- 1 Any use of the appliance requires precise knowledge and observation of these operating instructions.
- 2 The appliance is intended only for the purposes specified in the Operating Manual or for purposes confirmed in writing by Drägerwerk AG.
- 3 The appliance should be inspected by experts at regular time intervals. An official report of the inspections should be drawn up.
- 4 Only original Dräger spare parts should be used for maintenance and repairs. Repairs and maintenance, and the replacement of spare parts should only be carried out by experts.
- 5 We recommend having inspections and repair work carried out by the Technical Customer Service of your Dräger Branch or Agent. Regular inspection is best ensured by entering into an Inspection Service Contract with the Technical Customer Service of your Dräger Branch or Agent.
- 6 Responsibility for the reliable function of the appliance passes to the owner or operator in all cases where the appliance has been inexpertly maintained or repaired by persons not employed by the Dräger Organisation or where it has been used in a manner which does not conform to the normal conditions of use.
- 7 For reasons of safety, pressure reducers should be overhauled at least every 6 years.

We would also point out that the national recommendations, regulations and laws governing the use of technical equipment should be observed.

DRÄGERWERK AG LÜBECK

### Contents

	Page		Page
<b>Important Notice</b> .....	2	<b>6 Testing of Operational Readiness</b> .....	11
<b>1 Intended Use</b> .....	4	<b>7 Anaesthesia</b> .....	11
<b>2 Technical Data</b> .....	4	7.1 Rapid Venting and Flushing of Circle System .....	12
<b>3 Mode of Operation and Definition of Terms</b> .....	4	7.2 Handling and Monitoring of CO <sub>2</sub> Absorbers .....	12
3.1 Semi-closed System (Partial Rebreathing System) .....	4	7.2.1 – Use of 1 Absorber .....	12
3.1.1 – Spontaneous Breathing .....	4	7.2.2 – Use of 2 Absorbers .....	12
3.1.2 – Manual Ventilation .....	5	7.3 Further Use of Circle System without Previous Disinfection or Sterilization ..	12
3.1.3 – Automatic (Controlled or Assisted) Ventilation with Pressure Limitation at Circle System .....	5	<b>8 Shutdown</b> .....	12
3.1.4 – Automatic (Controlled or Assisted) Ventilation with Pressure Reserve of Lung Ventilator .....	5	<b>9 Cleaning, Disinfection, Sterilization</b> .....	13
3.1.5 – Manual Inflation .....	6	9.1 Disassembly of Circle System .....	13
3.2 Semi-open System .....	6	9.2 Cleaning .....	14
3.3 Closed System .....	6	9.3 Disinfection/Sterilization .....	14
3.4 Use with Anaesthesia Spiromat .....	6	9.4 Treatment of Rubber Parts .....	14
3.5 CO <sub>2</sub> Absorber .....	7	9.5 Assembly of Circle System .....	14
<b>4 Special Notes</b> .....	8	<b>10 Functional Test</b> .....	15
4.1 Respiratory Pressure Gauge Precom and Volumeter .....	8	10.1 Testing with Tester .....	15
4.2 Oxygen Meter Oxycom® 100D .....	8	10.2 Testing on Anaesthetic Apparatus .....	15
4.3 Removal of Excess Anaesthetic Gas .....	8	10.2.1 – Leak Test .....	15
4.4 Bacterial Filter .....	8	10.2.2 – Testing of Relief Valve .....	15
4.5 CO <sub>2</sub> Enrichment .....	8	10.2.3 – Testing of Unidirectional Valve for Spontaneous Breathing .....	15
4.5.1 – by CO <sub>2</sub> Supply .....	8	10.2.4 – Functional Testing of Inspiratory and Expiratory Valves .....	16
4.5.2 – by Removing Absorber .....	8	10.2.5 – Final Test .....	16
4.6 Use of Trichlorethylene or Chloroform .....	9	10.3 Testing of Closed System (Maximum Requirements) .....	16
<b>5 Preparations prior to Performance of Anaesthesia</b> .....	9	10.3.1 – Leak Test I .....	16
5.1 Preparation of Circle System .....	9	10.3.2 – Leak Test II .....	16
5.2 Connection to Anaesthetic Apparatus or Anaesthesia Lung Ventilator .....	9	10.3.3 – Leak Test III .....	17
5.2.1 – Mixed-gas Connector .....	9	10.3.4 – Testing of Relief Valve .....	17
5.2.2 – Connection of Breathing Bag or Ventilator .....	9	10.3.5 – Testing of Unidirectional Valve for Spontaneous Breathing .....	17
5.2.3 – Connection of Equipment for Removal of Excess Anaesthetic Gas .....	10	10.3.6 – Testing of Inspiratory and Expiratory Valves .....	17
5.2.4 – Connection of Oxycom® 100D .....	10	10.3.7 – Final Test .....	17
5.2.5 – Filling of CO <sub>2</sub> Absorbers .....	10	10.4 Test Chart (Summary of Tests) .....	17/18
5.2.6 – Connection of Breathing Tubes .....	11	<b>11 Maintenance, Inspection</b> .....	20
		<b>12 Parts List</b> .....	20
		<b>13 Order List</b> .....	21

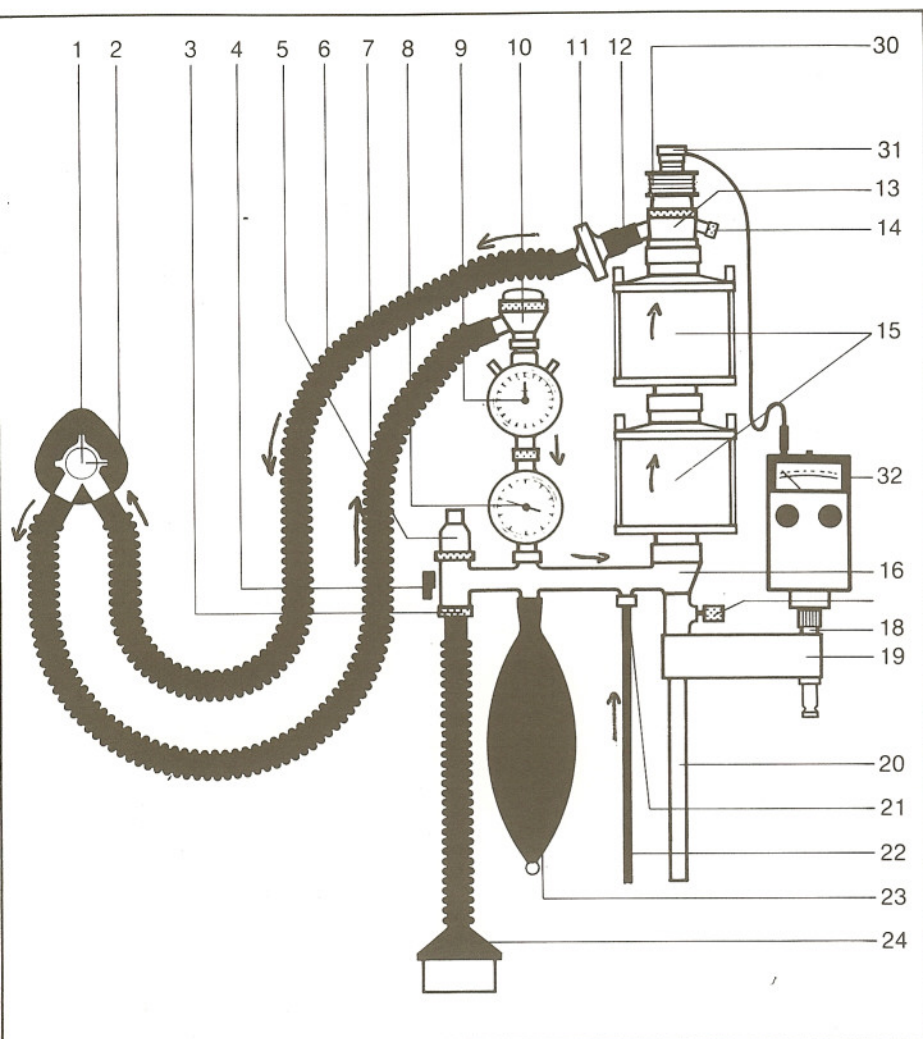

**Key to Fig. 1**

- 1 Y-piece for mask and catheter connection
- 2 Breathing mask
- 3 Unidirectional valve
- 4 Changeover valve
- 5 Relief valve (adjustable between 5 and 40 mbar)
- 6 Inspiratory tube
- 7 Expiratory tube
- 8 Respiratory pressure gauge
- 9 Dräger-Volumeter®
- 10 Expiratory valve
- 11 Bacterial filter
- 12 Mount for bacterial filter
- 13 Inspiratory valve
- 14 Mixed-gas connector at inspiratory valve
- 15 CO<sub>2</sub> absorber
- 16 Circle system carrier
- 17 Locking screw
- 18 Threaded stem for securing anaesthesia timer, sphygmomanometer and/or a holder for accommodating O<sub>2</sub> meter Oxycom® 100 D
- 19 Hinged arm
- 20 Rod for mounting and adjusting height of circle system
- 21 Mixed-gas connector at circle system carrier
- 22 Mixed-gas tube
- 23 Breathing bag (respiratory bag)
- 24 Anaesthetic filter set
- 30 Condenser
- 31 O<sub>2</sub> sensor
- 32 O<sub>2</sub> meter Oxycom® 100 D

Fig. 1 Circle System 7a with other accessories

37 726 a

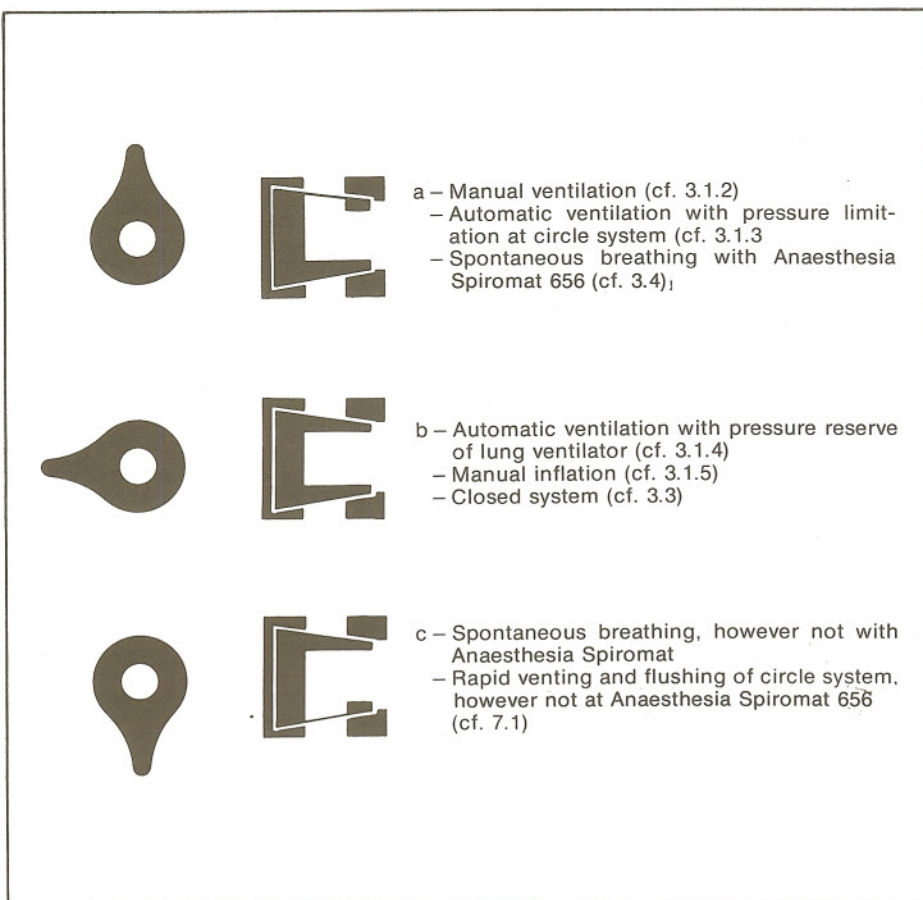

Fig. 2 Settings of changeover valve 4

37 727

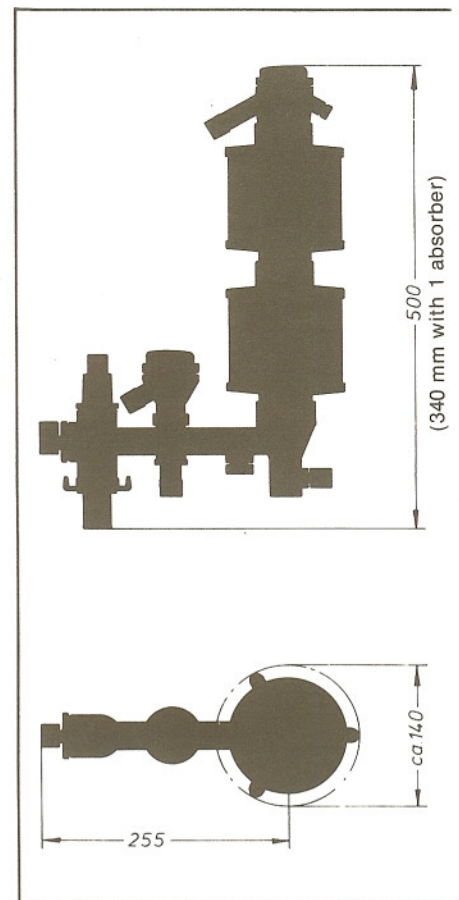

Fig. 3 Dimensions of circle system 7a

37 72

# 1 Intended Use

The circle system 7a (8 ISO, cf. footnote <sup>1)</sup>) is a patient system developed for anaesthetic apparatus. It is specially designed as a partial rebreathing system (semi-closed), but can also be used as a closed and semi-open system. The envisaged applications are spontaneous breathing, manual ventilation or automatic ventilation.

An ancillary device makes it possible to also use the circle system 7a for a dual-hose lung ventilator such as the Dräger Anaesthesia Spiromat 656 (separate routing of inspiratory and expiratory tubing from circle system 7a to anaesthesia lung ventilator; cf. Section 3 »Mode of Operation and Definition of Terms«).

<sup>1)</sup> The circle system is also available with ISO connections under the designation »Circle system 8 ISO«

# 3 Mode of Operation and Definition of Terms

## Single hose system

For spontaneous breathing or manual ventilation, the circle system 7a is provided with a breathing bag 23 which is connected to the breathing bag connection port 16.1 (cf. Fig. 15) of the circle system carrier 16. In the case of manual ventilation, handling can be improved by placing corrugated tubing (Item 25 in Fig. 21) between the breathing bag and circle system carrier.

For purposes of automatic ventilation with an anaesthesia lung ventilator, the breathing bag 23 of the circle system is generally replaced by the automatic bellows of the ventilator. The patient's inspiration and expiration take place via the same hose 33 (cf. Fig. 9), which connects the ventilator to the circle system (e. g. Ventilog).

Such arrangements will hereinafter be referred to as a »single hose system«.

## Dual hose system

The inspiratory and expiratory tubes of the Anaesthesia Spiromat 656 are routed separately thus permitting certain advantages in terms of operation (cf. Operating Manual for Anaesthesia Spiromat 656). A special adapter 34 (cf. Section 3.4 »Use with Anaesthesia Spiromat«) is provided for the connection of such a dual-hose lung ventilator. This adapter is attached to the breathing bag connection port by means of a manually-operated connection and separates the inspiratory branch from the expiratory branch in the circle system by way of a special design (cf. Figs. 7, 10 and 11). This arrangement will hereinafter be referred to as a »dual hose system«.

# 2 Technical Data

Dimensions	cf. Fig. 3
Weight	6.23 kg
Absorber volume	1 litre in each case
Resistance –	
– inspiratory valve	< 0.5 mbar at 20 l/min
– expiratory valve	< 0.5 mbar at 20 l/min
– unidirectional valve (for excess gas removal in case of spontaneous breathing at the end of expiration)	< 1 mbar at 20 l/min
Max. expiratory resistance	< 2 mbar at 10 l/min
Connection port diameter for breathing tubes*)	23 mm (for circle system 7a)
Connection port diameter for excess gas removal*)	27 mm (for circle system 7a)
Volume of breathing bag (other sizes available)	2.3 l
Breathing tube length	1 m
Mixed-gas connector	M 16 x 1.5
Max. leak rate with respect to atmosphere (without Volumeter)	0.2 l/min at 40 mbar (approx. 0.05 l/min at 10 mbar)

## 3.1 Semi-closed System (Partial Rebreathing System) Mode of Operation

The circle system 7a is primarily intended for the performance of anaesthesia in a semi-closed system. It permits savings on gas and anaesthetic, with the fresh gas flow per minute being less than the patient's minute volume. The O<sub>2</sub> component is however such that the patient receives more O<sub>2</sub> than he consumes. A proven value for the fresh gas flow is between 2 and 4 l/min of anaesthetic gas mixture.

### 3.1.1 Semi-closed System: Spontaneous Breathing

Single hose system: Lever of change-over valve 4 facing vertically downwards,

Dual hose system: Lever of change-over valve 4 facing vertically upwards.

In the case of spontaneous breathing the fresh gas supplied via the mixed-gas tube 22 during inspiration flows through the CO<sub>2</sub> absorber(s) 15, the in-

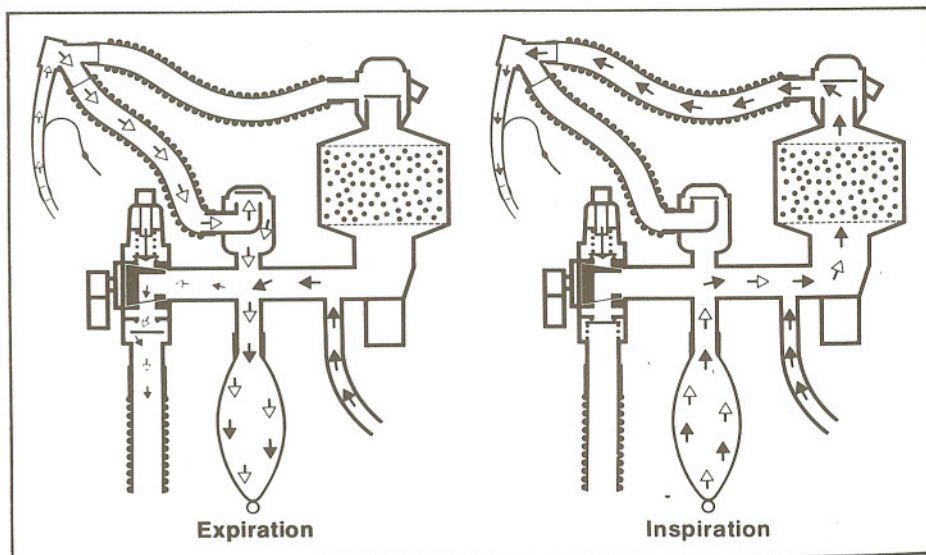

Fig. 4 Functional schematic »Spontaneous breathing« as per 3.1.1 (single hose system)

spiratory valve 13 and the inspiratory tube 6 to the patient (cf. Fig. 4, inspiration). In addition, the gas mixture consisting of fresh gas and the gas exhaled by the patient is sucked in from the breathing bag 23 and the CO<sub>2</sub> component removed in the absorber 15. The inspiratory resistance occurring during this process is caused by the soda lime and inspiratory valve 13 and is a function of the respective inspiratory flow. Given a flow of 20 l/min the resistance is < 0.5 mbar.

Single-hose and dual-hose systems differ in terms of expiration:

In the case of a **single hose system** the gas exhaled flows, together with the fresh gas being constantly fed in via the mixed-gas tube 22, via the expiratory tube 7 and the expiratory valve 10 (resistance < 0.5 mbar with a flow of 20 l/min) into the breathing bag 23 until the bag is full and the expiratory pressure is sufficient to open the low-resistance unidirectional valve 3 (cf. Fig. 4, expiration). Thus, at the end of the expiratory phase, any excess gas escapes via this unidirectional valve 3. The expiratory resistance caused by the equipment is determined by this valve 3 (< 1 mbar at 20 l/min).

With a **dual hose system**, the use of the dual hose adapter 34 (Figs. 7 and 10) prevents removal of the excess gas via the unidirectional valve 3 at the end of the expiratory period. In this case the gas is removed by way of a unidirectional valve in the Anaesthesia Spiromat (for further details see Section 3.4 »Mode of Operation with Adapter for Use with Anaesthesia Spiromat«).

### 3.1.2 Semi-closed System: Manual ventilation

Single-hose and dual-hose system:  
Lever of changeover valve 4 facing vertically upwards.

In the case of manual ventilation the gas mixture consisting of fresh gas and the gas exhaled by the patient flows, during the inspiratory period, out of the breathing bag 23 through the CO<sub>2</sub> absorber 15, the inspiratory valve 13 and the inspiratory tube 6 to the patient. During the inspiratory period the patient also receives the fresh gas supplied to the circle system (cf. Fig. 5, inspiration). The respiratory pressure can be infinitely limited between 5 and 40 mbar on the relief valve 5. In this case any excess gas escapes at the end of the inspiratory period through the unidirectional valve 3 via the relief valve 5.

Expiration takes place spontaneously by reduction of the increased pressure in the thorax. During the expiratory period the gas exhaled flows, together with the fresh gas being simultaneously

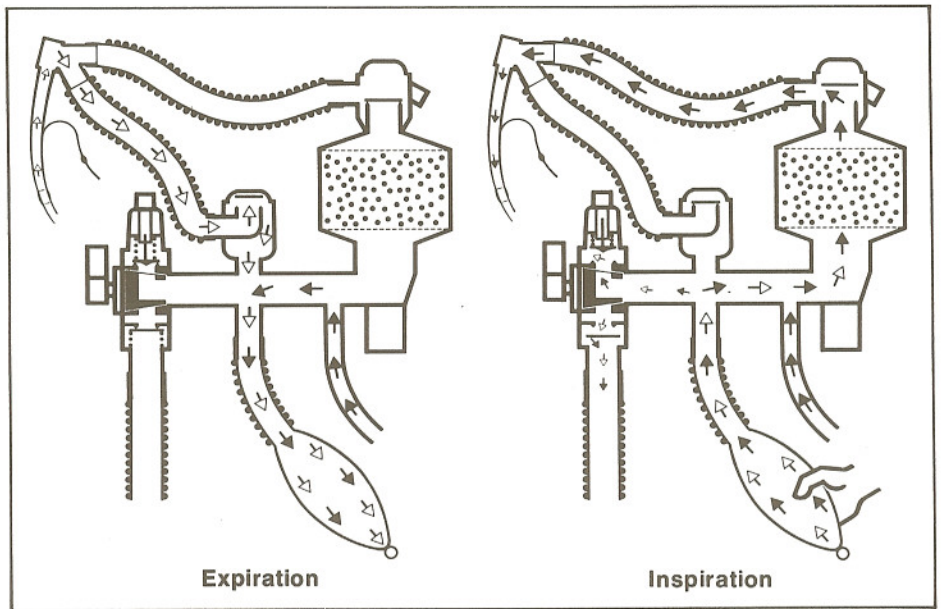

Fig. 5 Functional schematic »Manual ventilation« as per 3.1.2 (single hose system), also »Automatic ventilation with pressure limitation« as per 3.1.3 (single hose system)

fed in, into the breathing bag 23 (cf. Fig. 5, expiration). With manual ventilation the endexpiratory pressure is a function of the fresh gas flow, the inspiratory pressure limitation and the handling of the breathing bag 23. To enable the patient to exhale to 0 mbar, the fresh gas flow is to be selected such that the breathing bag is just sufficiently full at the commencement of the inspiratory period.

### 3.1.3 Semi-closed System: Automatic (Controlled or Assisted) Ventilation with Pressure Limitation at Circle System

Single-hose and dual-hose system:  
Lever of changeover valve 4 facing vertically upwards.

In the event of automatic ventilation with pressure limitation at the circle system 7a, the gas mixture consisting of fresh gas and the gas exhaled by the patient flows during the inspiratory period out of the bellows of the anaesthesia lung ventilator (Pulmomat 19 or Anaesthesia Spiromat) through the CO<sub>2</sub> absorber 15, the inspiratory valve 13 and the inspiratory tube 6 to the patient. During inspiration the patient also receives the fresh gas supplied to the circle system.

If the inspiratory limit pressure (adjustable between 5 and 40 mbar) set on the relief valve 5 of the circle system 7a is not attained, no gas escapes during the inspiratory period. In such cases the excess gas only escapes from the anaesthesia lung ventilator at the end of the expiratory period (cf. Operating Manual of the anaesthesia lung ventilator in question).

If, on the other hand, the pressure set at the relief valve 5 is reached, part of the excess gas escapes from the circle system at the end of the inspiratory period via the relief valve 5 and the unidirectional valve 3. When this method is employed the patient only receives (in contrast to »Automatic Ventilation with Pressure Reserve of Lung Ventilator«, cf. 3.1.4) that ventilatory volume which his lungs can take up in accordance with their compliance (up to the inspiratory pressure set on the relief valve 5).

If the setting of the relief valve 5 is too low, an excessive amount of anaesthetic gas is discharged through the relief valve 5 with the result that a vacuum is generated, depending on the ventilator used, due to a lack of volume. As a check use is to be made of a respiratory pressure gauge 8 or 28.

### 3.1.4 Semi-closed System: Automatic (Controlled or Assisted) Ventilation with Pressure Reserve of Lung Ventilator

Single-hose and dual-hose system:  
Lever of changeover valve 4 horizontal.

The pressure acting on the empty bellows of a ventilator at the end of inspiratory phase is the maximum working pressure of the ventilator. It is greater than the respiratory pressure displayed by the respiratory pressure gauge 8, 28 of the circle system. The difference between these two pressures is the »pressure reserve«, which serves for example in the case of obstructions to overcome the increased breathing resistance and maintain the ventilatory volume at a constant level.

The entire ventilatory volume set at the bellows of the ventilator is expelled. It must however be remembered that, when the relief valve 5 is closed (horizontal position of lever 4), the maximum working pressure may become effective in the circle system in the case of a small lung or low-compliance thorax, if an excessive ventilatory volume or high inspiration rate with long inspiration period is set or in the event that the fresh gas flow is excessive. As a check use is to be made of a respiratory pressure gauge 8 or 28.

### 3.1.5

#### Semi-closed System: Manual Inflation

Single-hose and dual-hose system:  
Lever of changeover valve 4 horizontal.

The circle system can be completely closed during manual ventilation for purposes of brief manual inflation of the patient's lungs. This setting must however be of a **short-term** nature, since excessive pressure may build up in the circle system on account of the inflow of fresh gas. As a check use is to be made of a respiratory pressure gauge 8 or 28.

### 3.2

#### Semi-open System Mode of Operation

Given an appropriately high fresh gas flow, the circle system 7a can also be used as a semi-open system. In such cases the flow of gas is greater than or equal to the patient's minute volume with the result that the entire expiratory

volume is exhaled into the open. This does however only apply unrestrictedly to a dual hose system (Anaesthesia Spiromat) where the inspiratory branch and expiratory branch are quite clearly separated (cf. Fig. 7). In the case of a single hose system (e. g. Pulmomat 19, breathing bag for spontaneous breathing or manual ventilation, cf. Figs. 4 and 5) part of the anaesthetic gas exhaled always remains in the circle system (partial rebreathing). Thus, even in the case of a high fresh gas flow (greater than the patient's minute volume), it is advisable to leave the CO<sub>2</sub> absorber 15 in the circle system (exception: cf. Section 4 »Special Notes«). As regards the various potential uses and settings of the changeover valve 4, the mode of operation of the circle system in the semi-open system corresponds to that of the semi-closed system.

### 3.3

#### Closed System Mode of Operation

Lever of changeover valve 4 in horizontal position.

In a closed system the amount of fresh gas supplied to the circle system after the induction phase corresponds to that required by the patient (cf. Fig. 6). Incorrect assessment of the anaesthetic uptake and the resultant supply of the various gas and anaesthetic components causes an increase or decrease in both the concentration and the pressure. The pressure and O<sub>2</sub> concentration **must** therefore be measured.

For the wake-up period the system is opened.

Before anaesthetic apparatus and a ventilator or an anaesthesia lung ventilator can be used to perform anaesthesia in a closed system, they must comply with certain prerequisites. Mandatory features for example are the metering of small fresh gas flows with sufficient accuracy and an adequate degree of gas-tightness in the low pressure system. During all ventilation phases, the ventilator must prevent gas from escaping from the system. If the circle system 7a is to be used as a closed system, we recommend prior consultation with the appropriate equipment manufacturers.

### 3.4

#### Use with Anaesthesia Spiromat Mode of Operation

The mode of operation of the circle system 7a when employing the dual-hose adapter 34 for use with an Anaesthesia Spiromat differs from a single hose system on account of the following special feature:

The relief valve 5 of the circle system 7a and thus also the unidirectional valve 3 – as well as the fresh gas supply – are located, due to the dual-hose adapter 34 (Fig. 7), in the inspiratory branch. To ensure that the fresh gas flowing in during the expiration phase remains primarily in the system even in the case of spontaneous breathing, the lever of the changeover valve 4 is to be positioned vertically upwards (in the same manner as for manual ventilation, cf. 3.1.2).

Given an appropriate setting of the relief valve 5, this ensures that manual assistance can be given at any time during spontaneous breathing. The fresh gas then flows – as with automatic ventilation – during the expiration phase via the inspiratory tube 35 (Fig. 7), which leads from the Anaesthesia Spiromat to the circle system, into the Anaesthesia Spiromat (cf. Fig. 7, expiration). Here it is routed, together with the gas exhaled by the patient via the expiratory tube 36 (Fig. 7), through an internal bypass into the breathing bag for spontaneous breathing/manual ventilation or into the bellows for automatic ventilation. In all cases the excess gas is removed at the end of expiration via a valve in the Anaesthesia Spiromat (cf. operating manual for Anaesthesia Spiromat 656).

The lever setting »vertically downwards« of the changeover valve 4 has no function when the circle system 7a is fitted with an adapter and used in conjunction with the Anaesthesia Spiromat (cf. Section 7.1 »Rapid Venting and Flushing of Circle System 7a«).

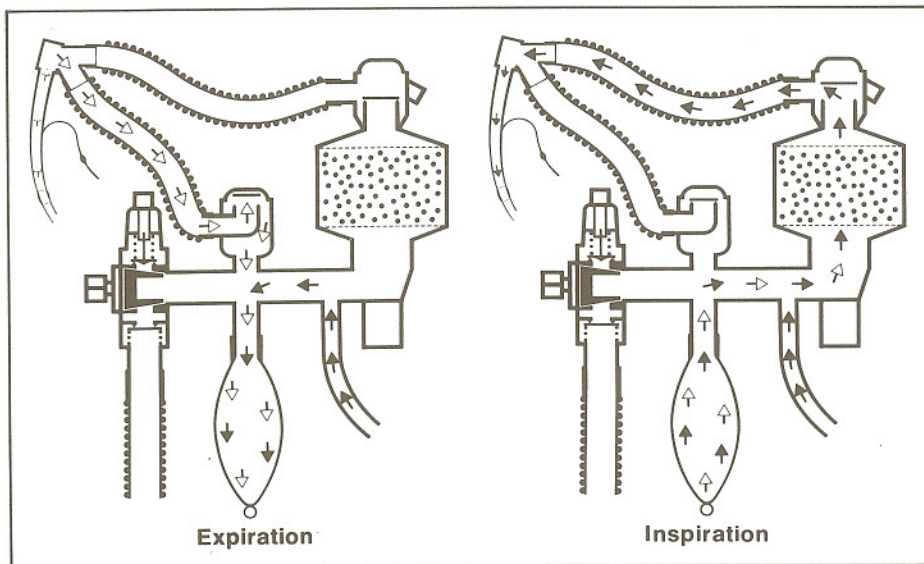

Fig. 6 Functional schematic »Closed system« as per 3.3, also »Manual inflation« as per 3.1.5 and »Automatic ventilation with pressure reserve« as per 3.1.4 (single hose system)

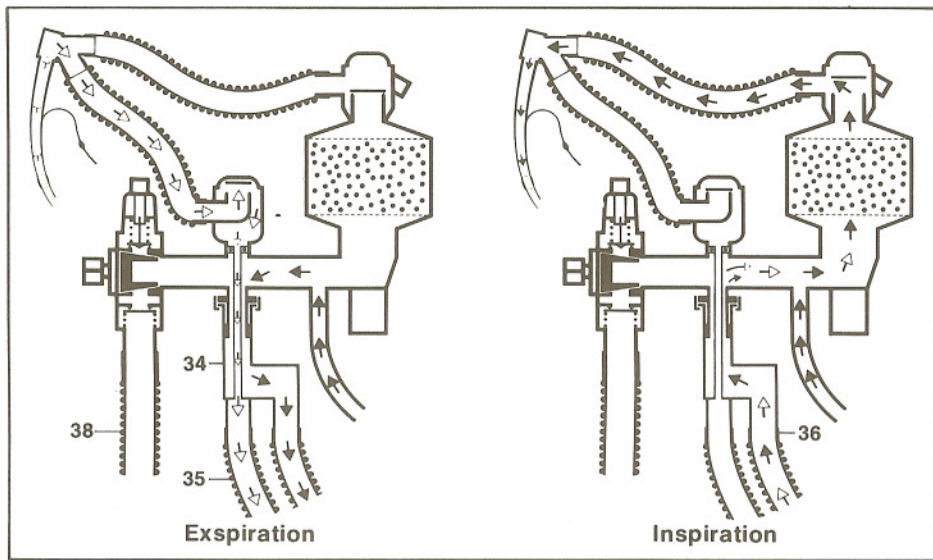

Fig. 7 Functional schematic »Automatic ventilation with adapter at Anaesthesia Spiromat 656« as per 3.4 (dual hose system)

### 3.5 CO<sub>2</sub> Absorber Mode of Operation

The task of the soda lime (e. g. Dräger-sorb® 650 or 800) is to remove CO<sub>2</sub> from the breathing gas by means of absorption. Dräger-sorb® 650 is a granular soda lime, whereas Dräger-sorb® 800 is a spherical, solid substance consisting of a mixture of roughly 80% calcium hydroxide, 5% sodium hydroxide and 15% water. The CO<sub>2</sub> in the gas flowing through the absorber is chemically

combined, with heat and water being produced. The sodium hydroxide and calcium hydroxide are caused to react, whereby sodium carbonate and calcium carbonate are formed. The process is irreversible and thus the lime cannot be regenerated following CO<sub>2</sub> absorption.

A CO<sub>2</sub> absorber is designed to hold one litre of soda lime. One litre of Dräger-sorb

absorbs roughly 110 litres of CO<sub>2</sub> leaving a residual concentration (at the absorber outlet) of 0.5 vol.% CO<sub>2</sub>. These figures are based on a ventilatory volume of 10 l/min (20 x 0.5 l) and a CO<sub>2</sub> concentration of 4 vol.% in the gas mixture routed into the absorber (careful filling of the absorber is a prerequisite).

Given continuous operation and a CO<sub>2</sub> generation rate of 0.4 l/min on the part of the patient, the service life of 1 litre of soda lime in a closed system will be approximately 5 hours. With the above data a usage period of some 4 hours is recommended in order to guarantee a certain safety margin.

With a semi-closed system the following equation can be used as a basis for determining the approximate percentage increase in service life:

$$\frac{\text{Patient's minute volume} + \text{fresh-gas flow}}{\text{Patient's minute volume}}$$

The Dräger-sorb soda lime is provided with an indicator which changes colour from white to violet as the soda lime is used. In line with this colour change, the reaction zone – as can be seen from the formation of heat and the appearance of condensate – slowly shifts towards the top of the lime layer. In the event of non-utilization an already used lime charge may lose its violet colouring again. This colouring returns when the lime is again exposed to CO<sub>2</sub>, but with reduced intensity! Drägerwerk AG thus recommends changing the soda lime at least once a day.

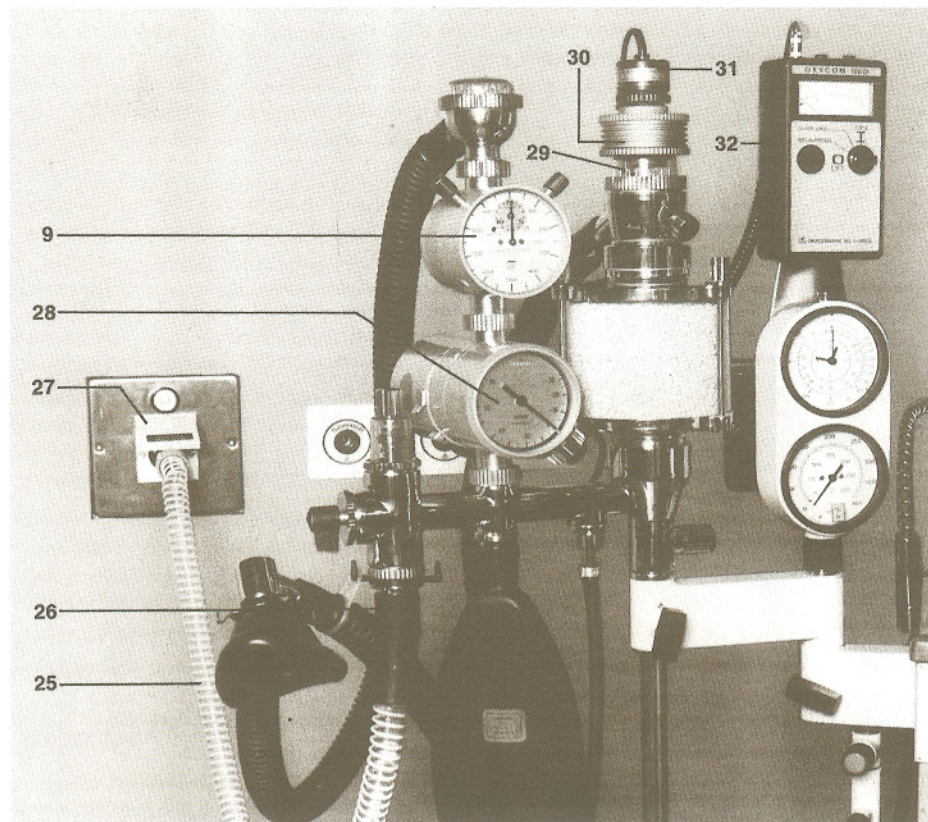

Fig. 8 Circle system 7a on anaesthetic apparatus, ready for spontaneous breathing, with respiratory pressure gauge Precom, Dräger-Volumeter, O<sub>2</sub> meter Oxycom 100 D. Connection of circle system to a Dräger ejector-type extraction system for excess anaesthetic gas 27

#### Key to Figs. 7–11

- 9 Volumeter® 2000
- 25 Extraction hose for removal of excess anaesthetic gas
- 26 Extraction hose mount
- 27 Ejector-type extraction system for excess anaesthetic gas
- 28 Respiratory pressure gauge Precom®
- 29 Inspection cap for O<sub>2</sub> sensor connection
- 30 Condenser
- 31 O<sub>2</sub> sensor
- 32 O<sub>2</sub> meter Oxycom® 100 D
- 33 Hose connecting circle system 7a and Ventilog
- 34 Adapter for Anaesthesia Spiromat® 656
- 35 Hose connecting circle system 7a and Anaesthesia Spiromat 656 (expiration)
- 36 Hose connecting circle system 7a and Anaesthesia Spiromat 656 (inspiration)
- 37 Extraction equipment for excess anaesthetic gas at Anaesthesia Spiromat 656
- 38 Hose connecting circle system 7a and Anaesthesia Spiromat 656 for removal of excess anaesthetic gas

## 4 Special Notes

on the use of mandatory monitoring devices and the operation of other miscellaneous equipment (standard and ancillary units).

### 4.1 Respiratory Pressure Gauge Precom and Volumeter

The general use of a respiratory pressure gauge **8** or **28** and a Volumeter **9** is urgently recommended by Drägerwerk AG. Should a breathing tube **6**, **7** become disconnected, air from the atmosphere would be sucked in via the expiratory valve **10** in the case of automatic ventilation and the Volumeter **9** would indicate the air intake. The volume transported by the ventilator during inspiration would escape via the disconnection (between the inspiratory and expiratory valve) and not be supplied to the patient. Thus the Volumeter display would only simulate a ventilator volume. Such an error can only be detected by a respiratory pressure gauge.

In addition to a pressure display, the Dräger Precom respiratory pressure gauge **28** (Figs. 8 and 9) is provided with a warning device, which triggers an acoustic alarm if the set alarm threshold is not reached. This threshold can be set between +10 and +80 mbar and -10 and -30 mbar (cf. Precom operating manual).

In the event of tube disconnection during spontaneous breathing, the patient would inhale air from the atmosphere via the leak. The air exhaled would either partially or completely escape into the open depending on the location of the disconnection. In such a case the Volumeter **9** would indicate either no or an inadequate volumetric flow and thus call attention to the disconnection (cf. Volumeter operating manual).

### 4.2 Oxygen Meter Oxycom 100 D

Drägerwerk AG recommends the use of the Oxygen Meter Oxycom 100 D (**32** in Figs. 8 and 10) for monitoring the O<sub>2</sub> concentration. This device continuously displays the O<sub>2</sub> content of the inspiratory gas mixture. The O<sub>2</sub> sensor **31** is attached to the inspiratory valve **13** by way of a special inspection cap **29** and a condenser **30**. If an adjustable lower alarm threshold is dropped below, the Oxycom 100 D gives an acoustic alarm (cf. Oxycom 100 D operating manual). By looking through the inspection cap **29** the correct functioning of the valve disc can be checked (see also chapter 6 and 10.2.4).

### 4.3 Removal of Excess Anaesthetic Gas

A connection port is provided underneath the unidirectional valve **3** for removal of excess gas. Such excess-gas removal is prescribed by the German Employer's Liability Insurance Association to preclude the possibility of operating-theatre personnel being endangered by various anaesthetics.

The following devices are available from Drägerwerk AG for attachment to this connection port:

- Anaesthetic filter (for 8 hours of operation), cf. brochure »Anaesthetic Filter 633«,
- Ejector-type extraction system (to be provided by the customer), cf. operating manuals »Central Supply Units« and »Anaesthetic Gas Extraction Coupling«.

### 4.4 Bacterial Filter

The installation of a bacterial filter **11** (cf. Fig. 1) in the circle system prevents bacteria from a possibly contaminated breathing system from entering the sterile breathing tubes **6**, **7** (cf. also 7.3 on Page 12).

The bacterial filter is fitted in accordance with Fig. 1 between the inspiratory valve **13** of the circle system and the inspiratory tube **6** using a mount **12** (take note of instructions given in operating manual »Bacterial Filter«).

### 4.5 CO<sub>2</sub> Enrichment

There are two possible ways of enriching the inspiratory gas with CO<sub>2</sub>. If the anaesthetic apparatus is provided with a CO<sub>2</sub> ancillary unit, CO<sub>2</sub> can be added to the flow of fresh gas via the flowmeter unit. Should such a unit not be available, an inspiratory CO<sub>2</sub> concentration can be achieved in the circle system by removing the CO<sub>2</sub> absorber **15**.

#### 4.5.1 CO<sub>2</sub> Enrichment by CO<sub>2</sub> Supply

If CO<sub>2</sub> is supplied via the fresh-gas flow set on the anaesthetic apparatus, the mixed-gas tube **22** must be connected above the absorber at the mixed-gas connector **14** of the inspiratory valve. If CO<sub>2</sub> were to be supplied at the mixed-gas connector **21**, the intentionally-supplied CO<sub>2</sub> component would be chemically combined in the soda lime and the temperature increased.

Before connecting the mixed-gas tube **22** at the inspiratory valve **13**, the lock nut **14.1** (Figs. 15 and 16) must first be unscrewed from the connector **14** and attached to the connector **21** at the circle system carrier in order to seal the connector **21**.

If CO<sub>2</sub> is supplied via the fresh-gas flow, it must be remembered that the resultant increased CO<sub>2</sub> absorption rate per unit time may cause a higher reaction temperature in the soda lime than is normally the case when CO<sub>2</sub> is produced solely by the patient. Given a CO<sub>2</sub> absorption rate of 0.4 l/min (corresponding to the patient's own production) and a patient's minute volume of 10 l/min with 4 vol.% exhaled CO<sub>2</sub> in a closed system, the temperature in the absorber is a maximum of 55°C, reaching roughly 33°C in the mask under these conditions. On account of the above-mentioned temperatures, an additional supply of CO<sub>2</sub> in a closed system is **not permissible**, as otherwise the patient's trachea may be scorched!

In a semi-closed system, the fresh-gas flow, which, with CO<sub>2</sub> supply from above the absorber, is routed into the circle system, counteracts the generation of heat for two reasons. On the one hand the fresh gas has a lower temperature than the gas in the circle system and on the other it ensures that part of the overall amount of CO<sub>2</sub> (CO<sub>2</sub> exhaled by the patient + CO<sub>2</sub> supply) is removed with the excess gas and does not therefore need to be absorbed by the soda lime. The percentage reduction in the amount of CO<sub>2</sub> is approximately as follows:

$$\frac{\text{Fresh-gas flow}}{\text{Patient's minute volume} + \text{fresh-gas flow}} \cdot 100$$

Example:

Fresh-gas flow = 5 l/min

Patient's minute volume = 10 l/min

$$\text{Reduction} = \frac{5}{10+5} \cdot 100 = 33\%$$

In order to avoid increases in temperature, the fresh-gas flow in a semi-closed system should thus be set to an appropriately higher level, the greater the CO<sub>2</sub> supply.

In a semi-open system (cf. 3.2) the supply of CO<sub>2</sub> presents no problems as regards generation of heat.

#### 4.5.2 CO<sub>2</sub> Enrichment by Removing Absorber

Removal of the two absorbers **15** means that the patient re-inhales the CO<sub>2</sub> which he produces. The resultant cumulation of CO<sub>2</sub> in the circulating breathing-gas mixture can be utilized to stimulate breathing activity. It must however be



remembered that the CO<sub>2</sub> concentration may increase in an uncontrolled manner depending on the fresh-gas flow rate and thus the proportion of excess gas. In this case the CO<sub>2</sub> concentration in the circle system will be higher, the smaller the flow of fresh gas.

## 5 Preparations prior to Performance of Anaesthesia

### 5.1 Preparation of Circle System

It is advisable to assemble and fit out the circle system 7a in the care and maintenance centre following disinfection or sterilization. As regards equipping of the circle system, attention is to be paid to Section 4 »Special Notes«. When performing assembly work, particular care is to be taken to ensure the following:

- The presence of sealing rings at the screw connections in the expiratory branch (circle system carrier 16, respiratory pressure gauge 8, 28, Volumeter 9).
- The use of intact valve discs 13.5, 10.2 (Fig. 15) in the inspiratory and expiratory valve 13, 10.
- The use of fresh soda lime.

Detailed information regarding assembly work following disinfection or sterilization is given in Section 9.5.

Following assembly the circle system is mounted by way of the mounting hole in the circle system carrier 16 on the stem of the hinged arm 19 or the rod 20 of the anaesthetic apparatus or anaesthesia lung ventilator to be used.

### 5.2 Connection to Anaesthetic Apparatus or Anaesthesia Lung Ventilator

#### 5.2.1 Mixed-Gas Connector

The mixed-gas tube 22, by which the fresh gas is routed into the circle system, can be attached either at the mixed-gas connector 21 (circle system carrier) or at the mixed-gas connector 14 (inspiratory valve). If it is connected to 21

### 4.6 Use of Trichloroethylene or Chloroform

**Important!** If use is made of soda lime, the circle system may not be employed to perform anaesthesia with trichloro-

ethylene or chloroform, as otherwise toxic compounds form. Such anaesthetics may thus only be used in the circle system in the semi-open mode with or without partial rebreathing following removal of the CO<sub>2</sub> absorbers.

(circle system carrier), the fresh gas is humidified and its temperature regulated in the absorber. In the event of a CO<sub>2</sub> supply, the mixed-gas tube 22 must, however, be attached at the inspiratory valve 14 (cf. Sections 4.5 and 4.5.1 »CO<sub>2</sub> Enrichment«). Connection to the anaesthetic apparatus or anaesthesia lung ventilator is made at the mixed-gas outlet in accordance with the operating manual for the anaesthetic apparatus or anaesthesia lung ventilator to be used.

#### 5.2.2 Connection of Breathing Bag or Ventilator

The following are optionally connected to the breathing bbag connection port 16.1 (cf. Fig. 15) of the circle system carrier:

- the breathing bag, if anaesthesia is to be performed exclusively by way of spontaneous breathing and no ventilator is to be connected,

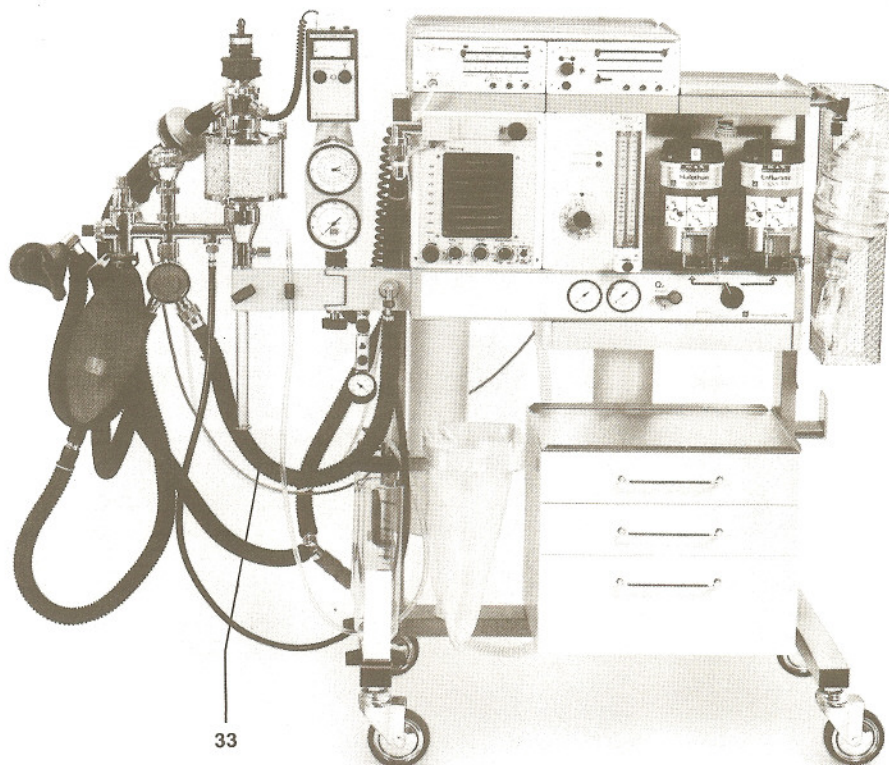

Fig. 9 Circle system 7a on anaesthetic apparatus Romulus 800 MV, ready for automatic ventilation, with Barolog, Spirolog, O<sub>2</sub> meter Oxycom 100 D, anaesthetic gas extraction and ventilator Ventilog

39 639

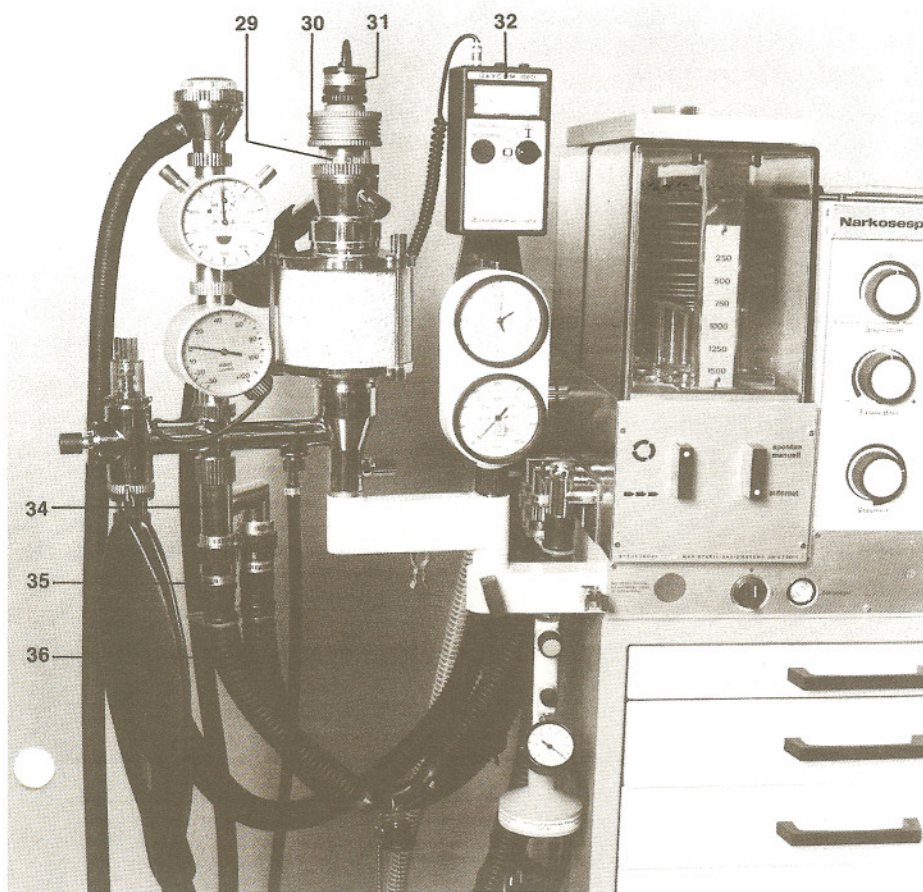

Fig. 10 Circle system 7a on Anaesthesia Spiromat 656, ready for automatic ventilation, with respiratory pressure gauge, Dräger-Volumeter, O<sub>2</sub> meter Oxycom 100D and dual hose adapter (see Page 7 for key)

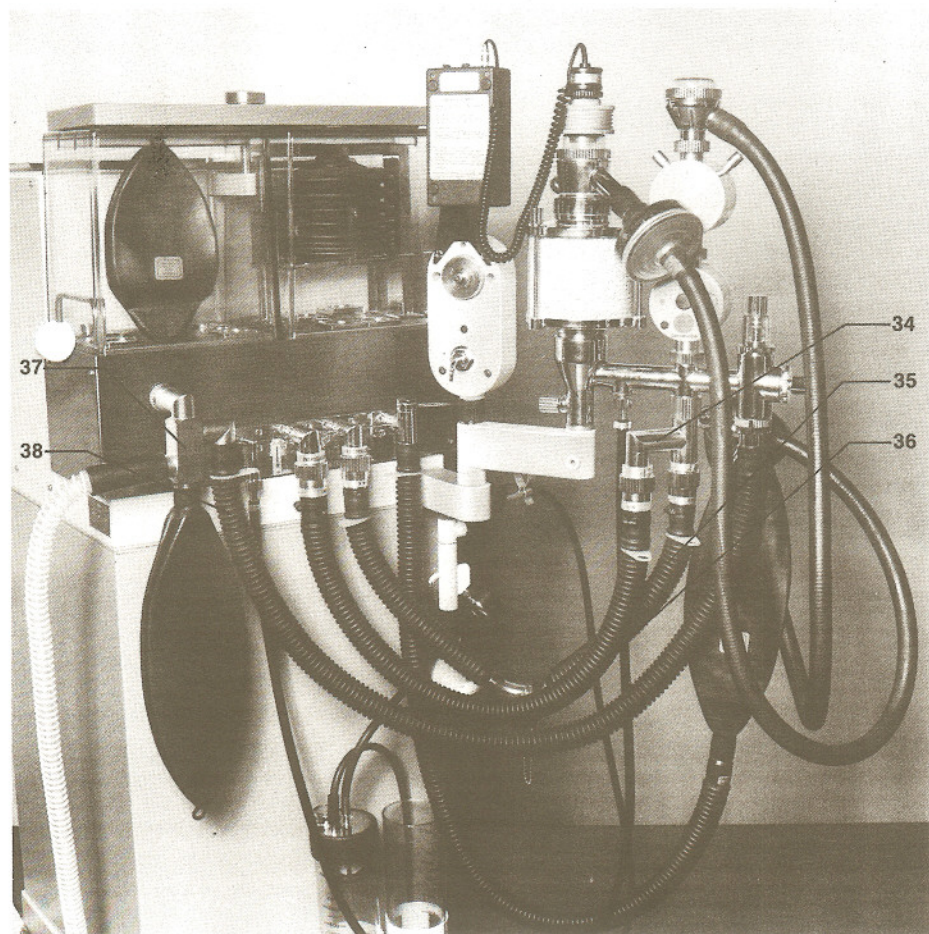

Fig. 11 Circle system 7a on Anaesthesia Spiromat 656 (rear view), with extraction equipment for excess anaesthetic gas 37 (see Page 7 for key)

- a corrugated hose with connection port and breathing bag, if anaesthesia is to be performed by way of spontaneous breathing and manual ventilation and no ventilator is to be connected,
- a corrugated hose for connection to a single-hose ventilator (e. g. Ventilog) for spontaneous breathing, manual ventilation and automatic (controlled or assisted) ventilation,
- a change-over switch for connection with a single-hose ventilator and a corrugated hose with connection sleeve and breathing bag,
- a dual-hose adapter with two corrugated hoses for connection to the Anaesthesia Spiromat 656. The connections for the inspiratory und expiratory tube for linking up the adapter with the Anaesthesia Spiromat 656 are such that the possibility of a mix-up is precluded.

### 5.2.3

#### Connection of Equipment for Removal of Excess Anaesthetic Gas

The waste-gas connection port underneath the unidirectional valve 3 is used for attaching the anaesthetic filter set 24 with fresh anaesthetic filter (Fig. 1) or linking up the ejector-type extraction system 27 by way of the hose 25, 26 (Fig. 8) (cf. also 4.3).

If a ventilator is used, one of these devices must likewise be connected to the excess-gas outlet port of the ventilator or this port is to be connected by way of a Y-piece and corrugated hose with the port of valve 3 of the circle system.

### 5.2.4

#### Connection of Oxycom® 100 D

The Oxycom 100 D O<sub>2</sub> meter (32 in Figs. 8 and 10) is attached by way of a connector on a plate, which is fastened either to the threaded stem 18 (Fig. 1) or to the instruments »sphygmomanometer/anaesthesia timer« (Figs. 8 and 10). The inspection cap 13.6 (Figs. 15 and 16) of the inspiratory valve 13 is to be replaced by a special cap 29 with appropriate threaded connection for mounting the O<sub>2</sub> sensor 31 and a condenser 30 which counteracts the formation of moisture on the sensor diaphragm. The condenser, and on top of it the O<sub>2</sub> sensor, are screwed onto this cap until they are tightly seated. The sensor cable is to be connected to the O<sub>2</sub> meter (cf. Oxycom 100 D operating manual).

### 5.2.5

#### Filling of CO<sub>2</sub> absorbers

The performance of anaesthesia using the circle system 7a presupposes the use of CO<sub>2</sub>-absorbing soda lime in all modes (cf. Mode of Operation – Sections 3.1 to 3.4).

Using a funnel, the absorbers 15 are filled as far as the lower edge of the upper

absorber cover with soda lime from the soda-lime container or from the special soda-lime filling unit Sorbator (cf. Fig. 12 and corresponding operating manual). In order to achieve optimum filling, the lime is to be compacted by tapping gently against the absorber jacket and

topping up the absorber several times if necessary. Depending on the desired application (cf. 7.2), either one or two absorbers filled with fresh soda lime are to be integrated into the circle system. After attachment, the tapered connections are to be turned slightly exerting

gentle pressure to ensure the firm, tight seating of the absorbers in the circle system. Absorbers filled with fresh soda lime, which are not intended for immediate use, are to be sealed so as to be airtight by means of a base **39** and a sealing cap **40** (cf. Fig. 13).

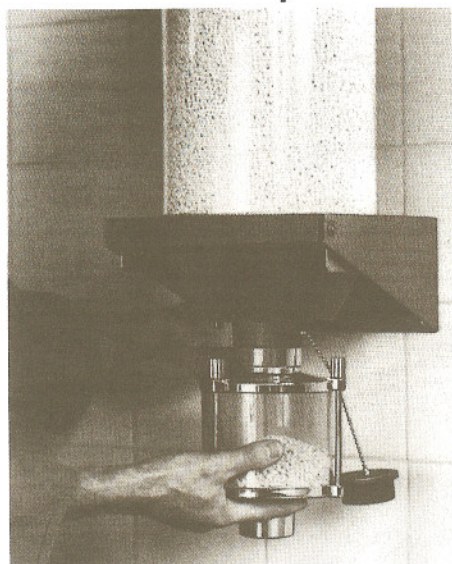

Fig. 12 Absorber filling unit Sorbator®

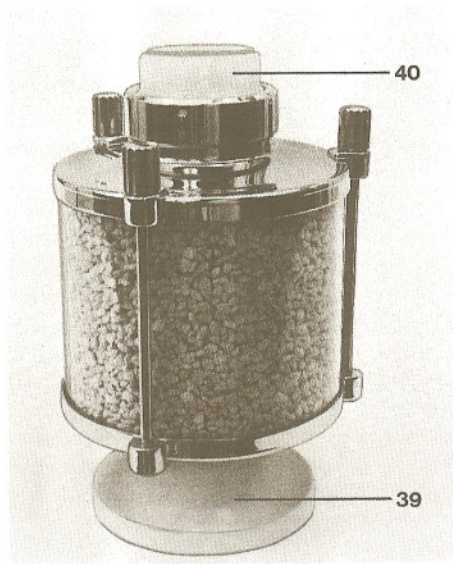

Fig. 13 CO<sub>2</sub> absorber with base **39** and sealing cap **40**

## 5.2.6

### Connection of Breathing Tubes

The circle system is to be equipped with the breathing tubes **6**, **7**, the Y-piece **1** and the mask **2** required for the patient or a catheter connector with catheter. The circle system 7a and 8 ISO (with ISO connections) require different breathing tubes. Care is thus to be taken to ensure that the correct breathing tubes are used for the respective circle system.

The pertinent regulations of the German Employer's Liability Insurance Association or other national authorities as regards the use of electrically-conductive and antistatic rubber or plastic parts to preclude possible hazards arising from electrostatic charging are to be observed.

## 6 Testing of Operational Readiness

The functional test as per Section 10 performed following cleaning and disinfection (or sterilization) is a prerequisite for use of the circle system with a patient.

**Immediately prior to use**, the user should repeat the test as described un-

der 10.2 in order to check the operational readiness of the circle system.

From commencement of and during the anaesthesia process a constant check should be kept to observe the correct functioning the valve discs in the inspiration and expiration valve.

## 7 Anaesthesia

Prior to commencement of anaesthesia, the operability of the circle system, the anaesthetic apparatus and any ancillary equipment such as a ventilator, Oxycorn 100 D O<sub>2</sub> meter, Precom respiratory pressure gauge etc. is to be checked and the devices switched on. The circle system is to be set in accordance with the respective mode of operation as described throughout Section 3.

**Important!** When switching from one mode of operation to another (spontaneous breathing, manual ventilation, automatic ventilation with pressure limitation at the circle system or automatic ventilation with pressure reserve of the lung ventilator), the changeover valve **4** is to be set accordingly. In the event of »manual ventilation« and »automatic

ventilation with pressure limitation at the circle system«, the relief valve **5** is to be set in accordance with the compliance of the patient's lungs.

Anaesthesia is delivered in accordance with medical and clinical requirements.

As regards induction, it must be remembered that the entire breathing system (circle system, ventilator and patient) does not yet contain the desired breathing gas mixture. Flushing out of the initially high nitrogen content can be accelerated in the semi-closed system with a relatively large fresh-gas flow. In the closed system induction is not possible.

As regards the wake-up period, the patient should discharge the anaesthetic

absorbed via the lungs as soon as possible. This can only be achieved with an appropriate concentration gradient between the patient and the breathing system; this is to be borne in mind when setting the fresh-gas flow made up from the individual gas components. In the closed system a wake-up period is not possible.

If a ventilator is being used, a switch is to be made to »spontaneous/manual« at the appropriate time for the wake-up period and breathing is to be manually aided if necessary. The breathing bag then gives the anaesthetist more control over re-establishment of the patient's own breathing. The ventilator is to be disconnected.

## 7.1 Rapid Venting and Flushing of Circle System

Differing methods of operation are required for rapid venting of the circle system to counteract for example an excessive build-up of pressure and for flushing the circle system during the wake-up period with the aid of the O<sub>2</sub> bypass of the anaesthetic apparatus or anaesthesia lung ventilator:

- In the case of a **single-hose system** (anaesthetic apparatus with Pulmomat 19 or connection of the breathing bag 23 to the breathing bag connection port), the lever of the changeover valve 4 is to be set such that it faces vertically downwards. The pressure is then instantaneously reduced to roughly 0.8 mbar. As is also the case with the gas occurring during flushing with the O<sub>2</sub> bypass, the excess gas is routed via the unidirectional valve 3 through the anaesthetic filter 24 or into the ejector-type extraction system 27 (cf. Fig. 8).
- With a **dual-hose system** (Anaesthesia Spiromat 656 with dual-hose adapter 34) the inspiratory tube and expiratory branch can only vented and flushed by way of the Anaesthesia Spiromat itself, since the relief valve 5 cannot vent the above-mentioned section of the circle system due to the use of the dual-hose adapter 34. The changeover lever of the Anaesthesia Spiromat is thus to be set to »spontaneous/manual«. As is also the case with the gas occurring during flushing with the O<sub>2</sub> bypass, the excess gas is removed by way of the waste-gas connection port of the Anaesthesia Spiromat. In this case the lever of the changeover valve 4 at

the circle system remains in its horizontal or vertically upwards position.

## 7.2 Handling and Monitoring of CO<sub>2</sub> Absorbers

### 7.2.1

#### Use of 1 Absorber

As regards handling two methods are possible. For CO<sub>2</sub> absorption, only one absorber is used in the circle system. A second absorber filled with fresh soda lime is kept in readiness (cf. Fig. 13). Once the soda lime in the absorber in use has been consumed, a switch is made to the stand-by absorber. This should be done when the Dräger-sorb 650 soda lime, which is provided with a colour indicator, is 50% or at the latest 66% discoloured. The CO<sub>2</sub> penetration rate is then roughly 0.5–1 vol.% given a patient's minute volume of 10 l/min (20 x 0.5 l). These figures are only a guide and the information given in Section 7.2.2 is always to be observed!

### 7.2.2

#### Use of 2 Absorbers

Another method guaranteeing improved lime utilization is to provide the circle system with two series-connected absorbers. Fig. 14 indicates the set-up required:

- A Both absorbers are filled with fresh soda lime and installed in the circle system.
- B The lower absorber remains in the circle system until the soda lime in it has been completely used up. Re-

sidual absorption of the CO<sub>2</sub> not absorbed by the lower absorber is assumed by the upper absorber.

- C The lower absorber has been removed to empty out the used soda lime and fill it with fresh soda lime.
- D The freshly-filled absorber has been re-installed as the upper absorber, to enable the soda lime in the lower absorber to again be utilized to the full.

**Note:** The colour indicator in the Dräger-sorb 650 or Dräger-sorb 800 should only be used as a guide and the discoloration is under no circumstances to be taken as a measure of the CO<sub>2</sub> penetration rate. Moreover a warm absorber only indicates that an absorption process is taking place. It does not give any indication of the actual absorption capacity.

## 7.3

### Further Use of Circle System without Previous Disinfection or Sterilization

If, following completion of anaesthesia, it is only intended to change the breathing tubes 6, 7, the Y-piece 1 and the mask 2 or catheter connector with catheter for the next patient, Drägerwerk AG recommends the use of a bacterial filter 11 between the inspiratory valve 13 and the inspiratory tube 6. If, on the other hand, the circle system is to be protected against contamination, a bacterial filter can also be fitted between the expiratory tube 7 and the expiratory valve 10.

If a bacterial filter 11 was used for the previous anaesthesia, this is to be replaced and sterilized provided that the markings on the label still permit sterilization (cf. usage instructions for bacterial filters).

The soda lime and anaesthetic filter can be re-used provided they still have adequate absorption capacity. The circle system is ready for re-use.

## 8 Shutdown

Following completion of anaesthesia, the circle system can – together with those parts of the ventilator which come into contact with the patient's air – be removed from the anaesthetic apparatus or anaesthesia lung ventilator for cleaning, disinfection or sterilization. Used soda lime and used anaesthetic filters (together with any bacterial filters which can no longer be sterilized) are to be discarded.

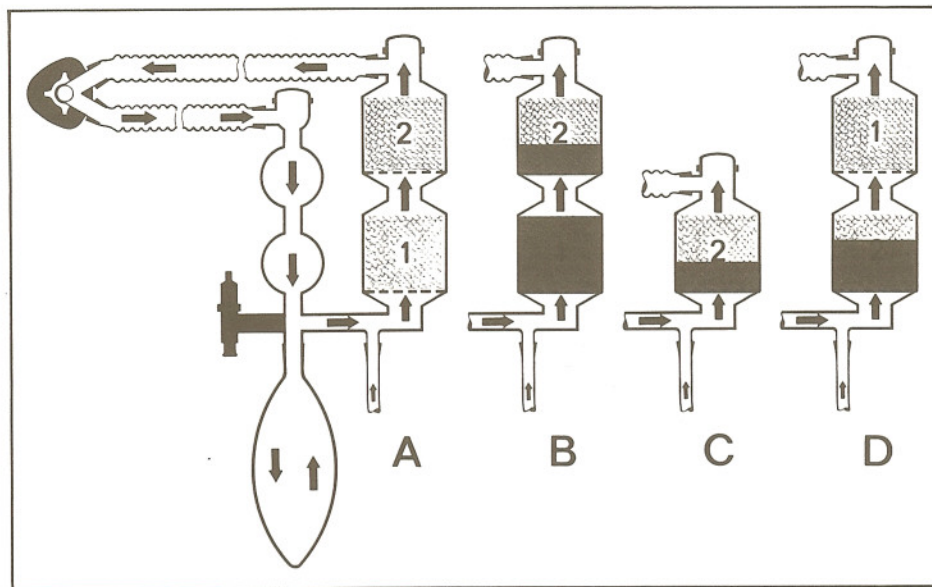

Fig. 14 CO<sub>2</sub> absorber set-up for 100% lime utilization

# 9

## Cleaning, Disinfection, Sterilization

For disinfection/sterilization purposes, a brand new circle system 7a is to be treated in the same manner as a used one. On account of the numerous different cleaning, disinfection and sterilization methods, only a rough outline can be given here in addition to specific information on how to treat a circle system. The specifications of the cleaning-agent and disinfectant manufacturers must always be precisely adhered to, in addition to the instructions concerning special cleaning, disinfection and sterilization procedures.

### 9.1 Disassembly of Circle System

- All rubber parts (breathing tubes, mask, breathing bag etc.) are to be removed from the circle system.
- The respiratory pressure gauge 8, 28, Volumeter 9 and sensor 31 of the Oxycom 100 D O<sub>2</sub> meter are to be removed and treated as stated in the corresponding operating manuals.
- If the circle system was used with an Anaesthesia Spiromat 656, the cap nut of the dual-hose adapter 34 (Figs. 10 and 11) at the circle system carrier is to be loosened and the adapter 34 removed vertically from the breathing bag connection port. This adapter is to be treated in the same manner as all other metal parts of the circle system.
- The circle system is to be disassembled as shown in Fig. 15.
- The inspiratory valve 13 contains a filter 13.2 which is held in position by means of a snap ring 13.1 (Fig. 16). This filter prevents lime dust from be-

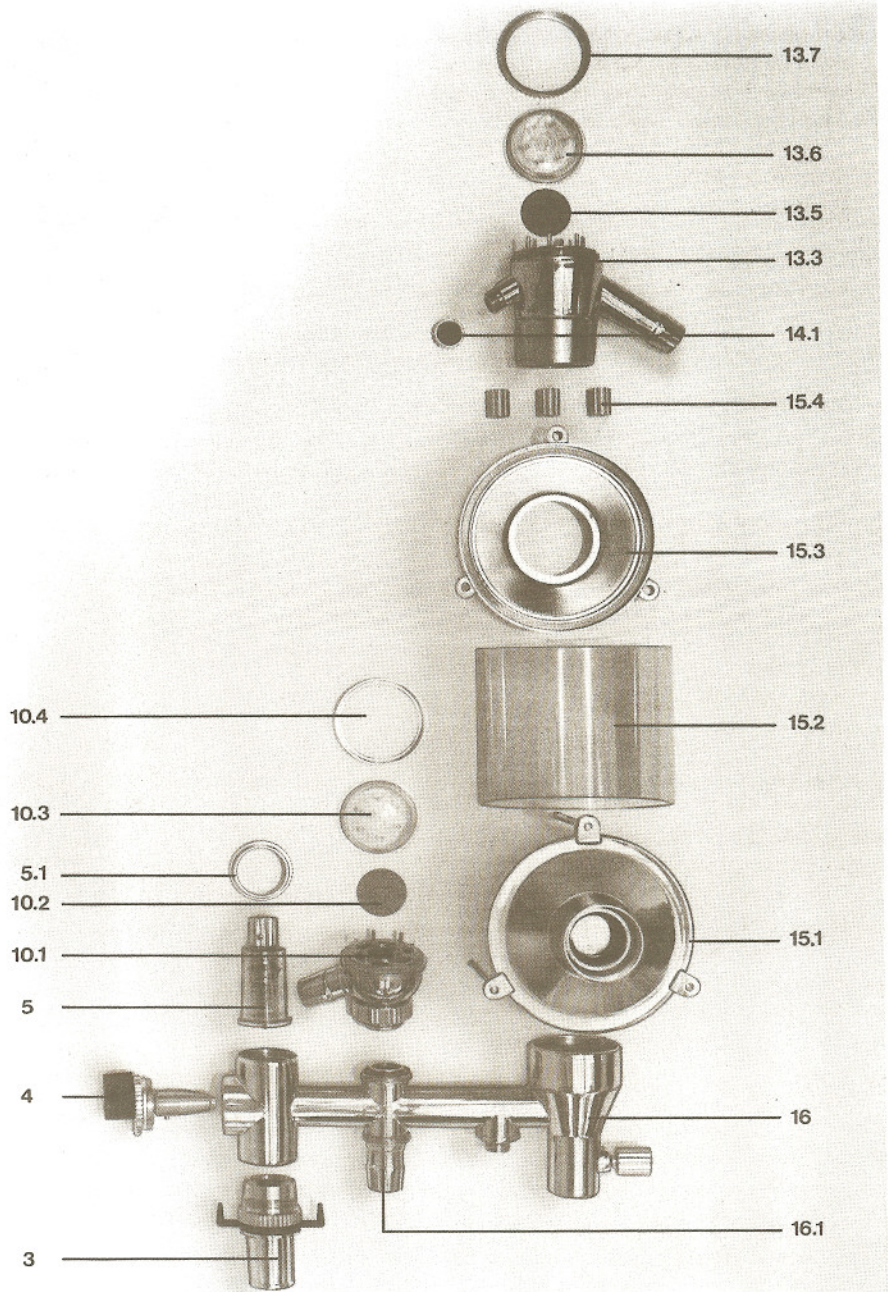

Fig. 15 Circle system 7a disassembled for cleaning purposes

#### Key to Figs. 15 and 16

- 3 Unidirectional valve
- 4 Changeover valve
- 5 Relief valve
- 5.1 Cap screw
- 10.1 Expiratory valve housing
- 10.2 Valve disc
- 10.3 Inspection cap
- 10.4 Cap nut
- 13.1 Snap ring
- 13.2 Filter
- 13.3 Inspiratory valve housing
- 13.4 Sealing ring
- 13.5 Valve disc
- 13.6 Inspection cap
- 13.7 Cap nut
- 14.1 Lock nut
- 15.1 Absorber base
- 15.2 Absorber jacket
- 15.3 Absorber cover
- 15.4 Clamping nut
- 16 Circle system carrier
- 16.1 Connection port for breathing bag

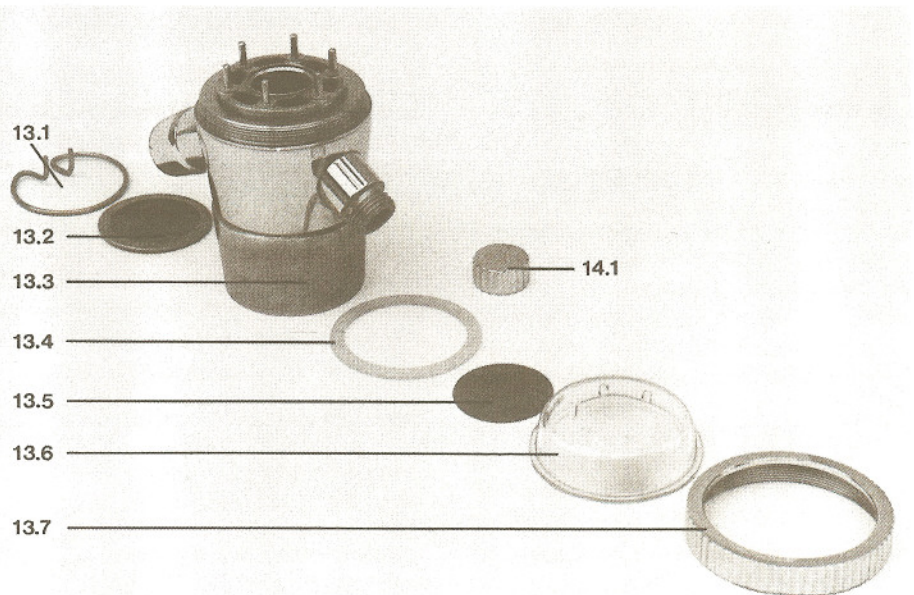

Fig. 16 Inspiratory valve completely disassembled

37 736

37 737

ing passed to the patient with the breathing gas via the inspiratory valve. For cleaning purposes it can be removed by pressing the snap ring **13.1** together. Drägerwerk AG recommends that this filter be re-installed together with the snap ring **prior** to disinfection or sterilization to prevent renewed contamination of the interior. The same applies to sealing rings.

**Important!** During all cleaning, disinfection and sterilization work there is an increased danger of circle system components being damaged! Damage to the following components can result in malfunction or leaks:

- valve seat and guide pins at inspiratory and expiratory valve, absorber and circle system carrier,
- outer and inner cone at inspiratory valve,
- lower sealing surfaces at connectors of expiratory valve, Volumeter and respiratory pressure gauge,
- tapered plug of changeover valve **4**,
- breathing bag connection port when a dual-hose adapter is being used,
- upper and lower sealing surface of absorber jacket,
- valve seat of relief valve **5** in circle system carrier,
- threaded connections at fresh-gas inlets at circle system carrier and inspiratory valve,
- upper rim of unidirectional valve **3**.

If several circle system are being treated at once, it must also be remembered that the tapered plug of the changeover valve **4** is ground-in in the valve seat of the circle system carrier and thus not interchangeable. Incorrect pairing will result in leaks!

## 9.2 Cleaning

Thorough cleaning is an absolute prerequisite for successful disinfection/sterilization. The cleaning of all circle system components should be linked to preliminary disinfection. All components illustrated in Figs. 15 and 16, as well as all rubber parts, can be placed in liquid disinfectant paying attention to the instructions given in Section 9.4. After the prescribed exposure time, they are to be thoroughly cleaned in running water. The use of softened, fully-demineralized or distilled water is recommended to prevent water spots.

After cleaning, the components are to be dried so as to give the greatest possible protection against corrosion and the growth of bacteria.

The Drägerwerk AG product range includes a variety of devices for facilitating cleaning, drying and disinfection:

- Dräger flushing unit 2M 8215 for breathing tubes, breathing bags etc.
- Dräger cleaning gun 2M 15138, especially for parts which are not readily accessible such as tubes and catheters,
- Dräger drying unit 2M 8220, especially for breathing tubes and Volumeters,
- Dräger/Miele combi-system, comprising a disinfection unit for fully-automatic cleaning and disinfection and an appropriately-matched drying cabinet (Dräger Siccator),
- Dräger Purfactor, for fully-automatic washing, disinfection, rinsing and drying of anaesthesia and surgical accessories.

## 9.3 Disinfection and Sterilization

If permitted by the disinfection or sterilization procedures employed following cleaning and drying, the parts of the circle system illustrated in Figs. 15 and 16 are to be treated in sub-assembly form or as complete units (cf. Section 9.5 for notes on assembly). For purposes of sterilization in superheated steam at 134°C in autoclaves, individual functional elements such as the inspiratory valve **13**, expiratory valve **10**, absorber **15**, circle system carrier **16** with relief valve **5**, changeover valve **4** and unidirectional valve **3** can be assembled for example without adversely affecting the sterilization process.

If disinfection or sterilization is to be performed in an assembled condition, the tapered plug of the changeover valve **4** is always to be greased with silicone grease **prior** to disinfection or sterilization (cf. 9.5).

Disinfection in the Dräger Aseptor requires that the individual functional elements be fitted together and that the circle system in the Aseptor be connected to a suction tube. This ensures that the interior of the circle system is also effectively disinfected in the assembled state.

Assembly **prior** to disinfection or sterilization has the advantage that the possibility of renewed contamination of the interior following disinfection/sterilization is reliably precluded. Otherwise particular care must be taken when assembling disinfected or sterilized components. As regards assembly work, the notes given in Section 9.5 are to be observed. Disinfection in the Dräger Aseptor is to be performed in

accordance with the »Guidelines for disinfection in the Aseptor«.

All parts illustrated in Figs. 15 and 16, as well as the dual-hose adapter can be sterilized in superheated steam at 134°C.

## 9.4 Treatment of Rubber Parts

Rubber parts such as tubes, masks, breathing bags and catheters are to be cleaned as described in Section 9.2. The use of hard brushes or materials which could damage the surface of the parts in question is however to be avoided.

In the case of parts incorporating cuffs, such as intubation catheters and breathing masks, the cuff must be carefully vented prior to cleaning and then resealed to prevent overstretching due to the effect of heat and also the penetration of liquid. On the other hand, prior to sterilization in superheated steam, the cuff is to be opened to prevent the cuff from bursting when the autoclave is evacuated.

Disinfectants containing phenol or phenyl compounds destroy rubber parts. It must also be remembered that if rubber or latex parts have been treated using disinfectants with a quaternary ammonium base, subsequent sterilization in superheated steam will result in damage. Thus, once selected, a particular disinfection method should be adhered to. Disinfection in the Dräger/Miele combi-system, the Dräger Purfactor or the Dräger Aseptor is eminently suitable for all rubber and latex instruments.

Sterilization in superheated steam at 120°C (glove programme) is also a possibility. Such sterilization in an autoclave does however always result in re-vulcanisation and thus in accelerated natural ageing. Moreover rubber parts may harden in the course of their service life due to the loss of softeners.

Exposure to ozone, such as that which can occur with UV lamps, has an adverse effect on rubber parts.

## 9.5 Assembly of Circle System

The circle system is assembled and fitted out in the reverse order to that employed for stripping down and disassembly. Attention is to be paid to possible damage such as that listed under Section 9.1. Immediate replacement of damaged parts precludes the need for time-consuming leak detection.

When spiral tubes are used (e. g. M 15 120, 2M 3969) the hose ends must be checked for their proper condition by kneading them between the fingers.

Before installing the unidirectional valve 3, it is to be ensured that the holes above it in the circle system carrier 16 are not blocked!

Prior to installation the tapered plug of the changeover valve 4 is to be greased

with a small quantity of silicone grease (e. g. **Oxigenoex S 4**), which is resistant to temperatures up to 134°C, approved for use in an oxygen atmosphere of 0.2 bar gauge pressure and physiologically sound.

The tapered plug is geared to a particular circle system carrier and may not be interchanged with those of other circle systems if leaks are to be avoided.

Proper engagement of the tapered plug is to be ensured.

Application of a small quantity of the above-mentioned silicone grease to the tapered connections of the inspiratory valve 13, absorber 15 and circle system carrier 16 cuts down the risk of leaks and facilitates disassembly when replacing an absorber.

## 10 Functional Test

Following disinfection or sterilization, the circle system is to be subjected to a functional test.

### 10.1 Testing with Tester

The Dräger Tester GPZ 2000 (Fig. 17), specially developed for the care and maintenance centre, permits easy, rapid checking of the circle system by way of measurement and simulation procedures. The test sequence is given on a test card attached to the tester (cf. also operating manual for GPZ 2000).

Should such a device not be available, in particular for example in operating theatres when checks are to be performed immediately prior to use, testing can be performed in accordance with Section 10.2.

If the circle system is to be used as a closed system, testing as per Section 10.3 is to be performed, since, with this mode, even more stringent requirements must be placed on the freedom from leaks of the system and valves.

### 10.2 Testing on Anaesthetic Apparatus

For the performance of such testing the circle system is to be fitted out as for actual use (e. g. with respiratory pressure gauge, Volumeter and if applicable sensors) and the absorber is to be filled with fresh soda lime (cf. Section 5 »Preparations prior to Performance of Anaesthesia«). This ensures that any leaks, which could no longer be detected in the case of subsequent fitting out, come to light during the test. The use of a respiratory pressure gauge 8 or 28 is mandatory for such testing.

The mixed-gas tube of the anaesthetic apparatus is attached to the mixed-gas connector 21 of the circle system carrier.

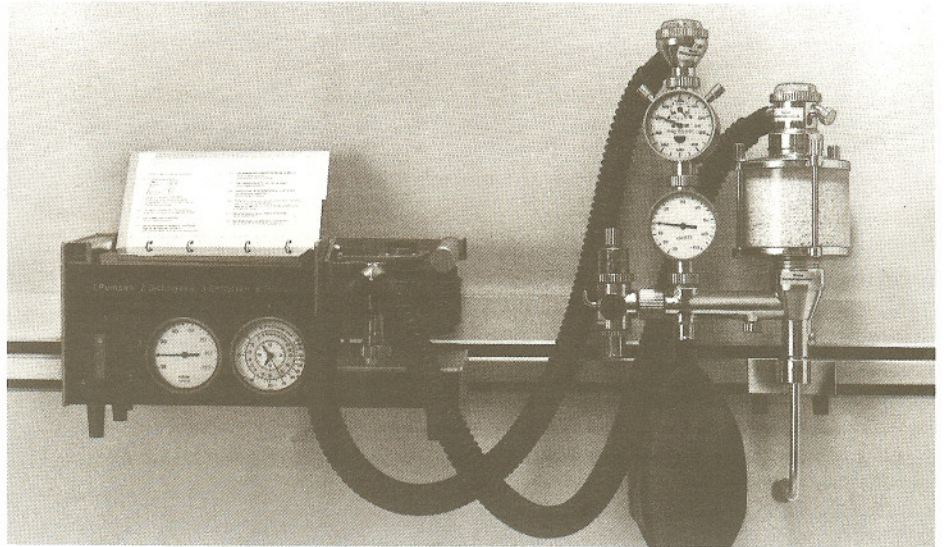

Fig. 17 Dräger-Tester GPZ 2000

#### 10.2.1 Leak Test

● Equip circle system with tubes as shown in Fig. 18. The corrugated hose to be connected for performance of this test (in place of the breathing bag) is attached to the mask cone of the Y-piece 1.

If the dual-hose adapter 34 for the Anaesthesia Spiromat is being used, the adapter is to be removed for the following test. When re-connecting the adapter after the test please make sure that the sealing rings are inserted and not damaged.

- Move lever of changeover valve 4 to horizontal position.
- Set a flow of 0.5 l/min at O<sub>2</sub> flowmeter of anaesthetic apparatus.
- Pressure indicated on respiratory pressure gauge must increase to > 40 mbar.

#### 10.2.2 Testing of Relief Valve

- The test set-up as per Fig. 18 is maintained.

- Connect and start up excess anaesthetic-gas removal equipment (ejector-type extraction system).
- Move changeover valve 4 to relief valve setting (lever vertically upwards).
- Set overall gas flow (O<sub>2</sub> and N<sub>2</sub>O) at flow control valves of anaesthetic apparatus or anaesthesia lung ventilator to 10 l/min.  
Set relief valve 5 initially to 20 mbar and then to 40 mbar. Compare the pressure values read off from the pressure gauge 8, 28 with the set values. The deviation should not exceed 15%.

#### 10.2.3 Testing of Unidirectional Valve for Spontaneous Breathing

- The test set-up as per Fig. 18 is maintained.
- Set changeover valve 4 to spontaneous breathing setting (lever vertically downwards).

- Set overall gas flow ( $O_2$  and  $N_2O$ ) at flow control valves of anaesthetic apparatus for anaesthesia lung ventilator to 10 l/min. The pressure may be a minimum of 0 mbar and a maximum of 2 mbar (the pressure gauge 8, 28 reading is to be estimated). If the pressure is clearly higher than that stated above, the hole in the changeover valve is to be checked for a free cross-section. If necessary the unidirectional valve 3 is to be replaced. If the pressure is clearly lower than that stated above, the anaesthetic-gas extraction system is to be checked. No vacuum – which opens the valve – may be generated at the unidirectional valve 3. The Dräger ejector-type extraction system is provided with vent holes in the mount 26 (Fig. 8) of the extraction hose 25 to prevent such vacuum.

#### 10.2.4

##### Functional Testing of Inspiratory and Expiratory Valves

- The test set-up corresponds to that for manual ventilation as per Fig. 5.
- A breathing bag is attached to the mask cone of the Y-piece 1.
- Perform visual inspection as to presence and intactness of valve discs (10.2 and 13.5 in Fig. 15) and check whether all guide pins are present and straight.
- Fill circle system with  $O_2$  until manual breathing bag and bag at Y-piece are inflated to roughly 5 mbar. Then close  $O_2$  flow control valve.
- Perform manual ventilation, observe valve disc: disc in inspiratory valve 13

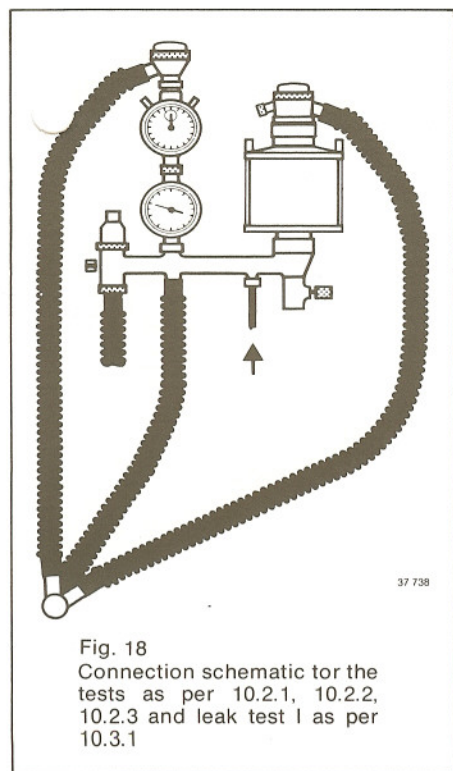

Fig. 18  
Connection schematic for the tests as per 10.2.1, 10.2.2, 10.2.3 and leak test I as per 10.3.1

should lift off during (and only during!) inspiration; disc in expiratory valve 10 should lift off during (and only during!) expiration.

- Observe Volumeter: even a slight drop in volume during the inspiratory phase indicates that the expiratory valve is defective.

#### 10.2.5

##### Final Test

Following completion of the tests as per 10.2.1–10.2.4, the circle system is to be made ready for actual anaesthesia.

- Check all hose connections.
- Check absorber charge.
- If applicable make connection to envisaged anaesthesia lung ventilator.

### 10.3

#### Testing of Closed System

**Test to ensure compliance with maximum requirements as regards freedom from leaks, in particular for use as a closed system**

If the circle system is to be used as a closed system, more exacting leak tests must be performed. These tests presuppose a gas metering potential of 0.05 l/min. If the anaesthetic apparatus in question cannot guarantee such metering, testing must be performed with the aid of an appropriate test flowmeter (range of measurement roughly 0.05–0.8 l/min) in the fresh-gas line to the circle system. As described at the beginning of Section 10.2, the circle system should be fully equipped before such testing is carried out.

#### 10.3.1

##### Leak Test I

(set-up as per Fig. 18)

Leak test I is designed to test the overall freedom from leaks of the circle system at a pressure of 40 mbar with respect to the atmosphere.

Permissible leakage rate:

0.4 l/min at 40 mbar  
(approx. 0.1 l/min at 10 mbar)

It must be remembered that the leak tests include the low-pressure system of the anaesthetic apparatus or anaesthesia lung ventilator – i. e. the system section from the mixed-gas tube back to the flowmeter unit is also part of their scope! Thus any leaks detected may also be located in the low-pressure system. A minor leak of 0.04 l/min is permissible in the low-pressure system at a pressure of 40 mbar and can be added to the abovementioned permissible leak-

age rates when performing testing on the anaesthetic apparatus (0.45 l/min).

Test procedure:

- Equip circle system with tubes as shown in Fig. 18. The corrugated hose to be connected for performance of this test (in place of the breathing bag) is attached to the mask cone of the T-piece.
- Turn tapered connections (inspiratory valve/absorber, absorber/circle system carrier) slightly exerting gentle, vertical pressure. A small quantity of silicone grease can be used if necessary to improve sealing.
- Slowly open  $O_2$  flow control valve at anaesthetic apparatus/anaesthesia lung ventilator or test flowmeter and fill circle system to a pressure of 40 mbar (read off on respiratory pressure gauge).
- Once the pressure has been attained, determine leakage flow I by setting the  $O_2$  flow such that the pressure 40 mbar neither decreases nor increases.
- If the leakage flow I is found to be less than that permitted (0.45 l/min for testing on anaesthetic apparatus or 0.4 l/min for testing using test flowmeter), the circle system is sufficiently leakproof. If, however, the value established is greater than that permitted, the cause of the leak is to be sought and eliminated. The following are possible causes:

- defective or missing sealing rings,
- loose thread,
- damaged tapered connection between circle system carrier and absorber,
- leaking valve seat at changeover valve,
- absorber jacket damaged at sealing edges or cracked.

If the leak cannot be eliminated, the circle system is to be replaced. If elements of the circle system are replaced, leak test I must always be repeated.

#### 10.3.2

##### Leak Test II

(set-up as per Fig. 19)

Leak test II is designed to test the seat of the expiratory valve 10 for leaks at a pressure of 40 mbar with respect to the atmosphere.

For all circle-system operating modes, the permissible leakage rate is 0.2 l/min at 40 mbar (approx. 0.05 l/min at 10 mbar).

In view of the fact that the leakage rate as per leak test I is included in the measurements for this test, the permissible leakage rate of 0.2 l/min is to be added to the established leakage flow I. The sum total is then the permissible leakage flow II.



Test procedure:

- Equip circle system with tubes as shown in Fig. 19.
- Slowly open O<sub>2</sub> flow control valve at anaesthetic apparatus/anaesthesia lung ventilator or test flowmeter and fill circle system to a pressure of 40 mbar (can be read off on respiratory pressure gauge).
- When the pressure of 40 mbar has been attained, determine leakage flow II by setting the O<sub>2</sub> flow such that the pressure of 40 mbar neither decreases nor increases.
- If the leakage flow II is found to be less than that permitted (leakage flow I + 0.2 l/min), the expiratory valve is sufficiently leakproof. If, however, the leakage flow II established is greater than that permitted, the disc and seat of the expiratory valve are to be checked and the damaged parts replaced if necessary. If the valve disc is replaced, leak test II is to be repeated. If the entire expiratory valve is replaced, leak test I is also to be repeated.

### 10.3.3 Leak Test III

(set-up as per Fig. 20)

Leak test III is designed to test the seat of the inspiratory valve 13 for leaks at a pressure of 40 mbar with respect to the atmosphere.

For all circle-system operating modes, the permissible leakage rate is 0.2 l/min at 40 mbar (approx. 0.05 l/min at 10 mbar).

In view of the fact that the leakage rate as per leak test II is included in the measurements for this test, the permissible leakage rate of 0.2 l/min is to be added to the established leakage flow II. The sum total is then the permissible leakage flow III.

Test procedure:

- Equip circle system with tubes as shown in Fig. 20.
- Remove inspiratory valve 13 from absorber 15 and hold in vertical position.
- Seal absorber 15 with sealing cap 40 (cf. Fig. 13). This is the difference in set-ups between Figs. 19 and 20.
- Slowly open O<sub>2</sub> flow control valve at anaesthetic apparatus/anaesthesia lung ventilator or test flowmeter and fill circle system to a pressure of 40 mbar (can be read off on respiratory pressure gauge 8, 28).
- When the pressure has been attained, determine leakage flow III by setting the O<sub>2</sub> flow such that the pressure of 40 mbar neither decreases nor increases.
- If the leakage flow III is found to be less than that permitted (leakage flow II + 0.2 l/min), the inspiratory valve is sufficiently leakproof. If, however, the leakage flow III established is greater than that permitted, the disc and seat of the inspiratory valve are to be checked and the damaged parts replaced if necessary. If the valve disc is replaced, leak test III is to be repeated. If the entire inspiratory valve is replaced, leak tests I and II are also to be repeated.

### 10.3.4

#### Testing of Relief Valve

The procedure for this test is identical to that described under Section 10.2.2.

### 10.3.5

#### Testing of Unidirectional Valve for Spontaneous Breathing

The procedure for this test is identical to that described under Section 10.2.3.

### 10.3.6

#### Testing of Inspiratory and Expiratory Valves

Leak tests II and III establish whether the expiratory and inspiratory valves are leakproof, but the test as per Section 10.2.4 must also be performed in order to check their function.

### 10.3.7

#### Final Test

Perform final test as per Section 10.2.5.

## 10.4 Test Chart

The chart 10.4 on Page 18 gives a summary of the tests to be performed as per Sections 10.2 and 10.3.

The operational readiness of the circle system is to be tested in accordance with Section 10.2 (Page 15) immediately prior to its use with a patient.

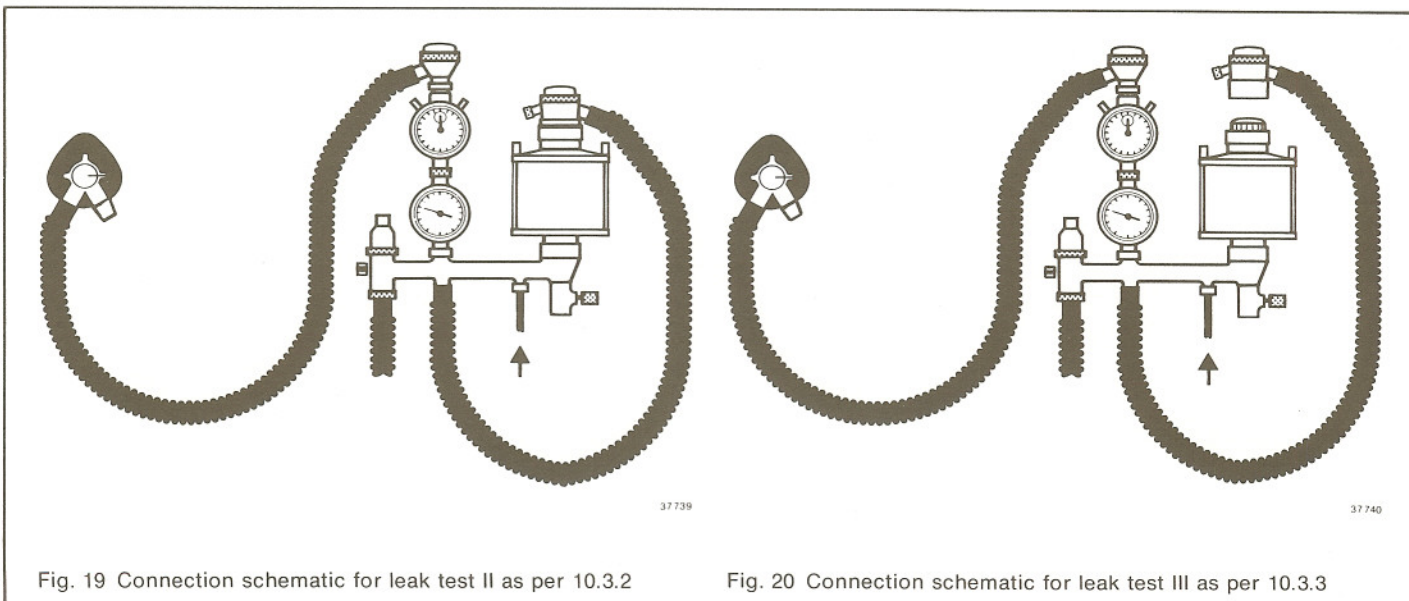
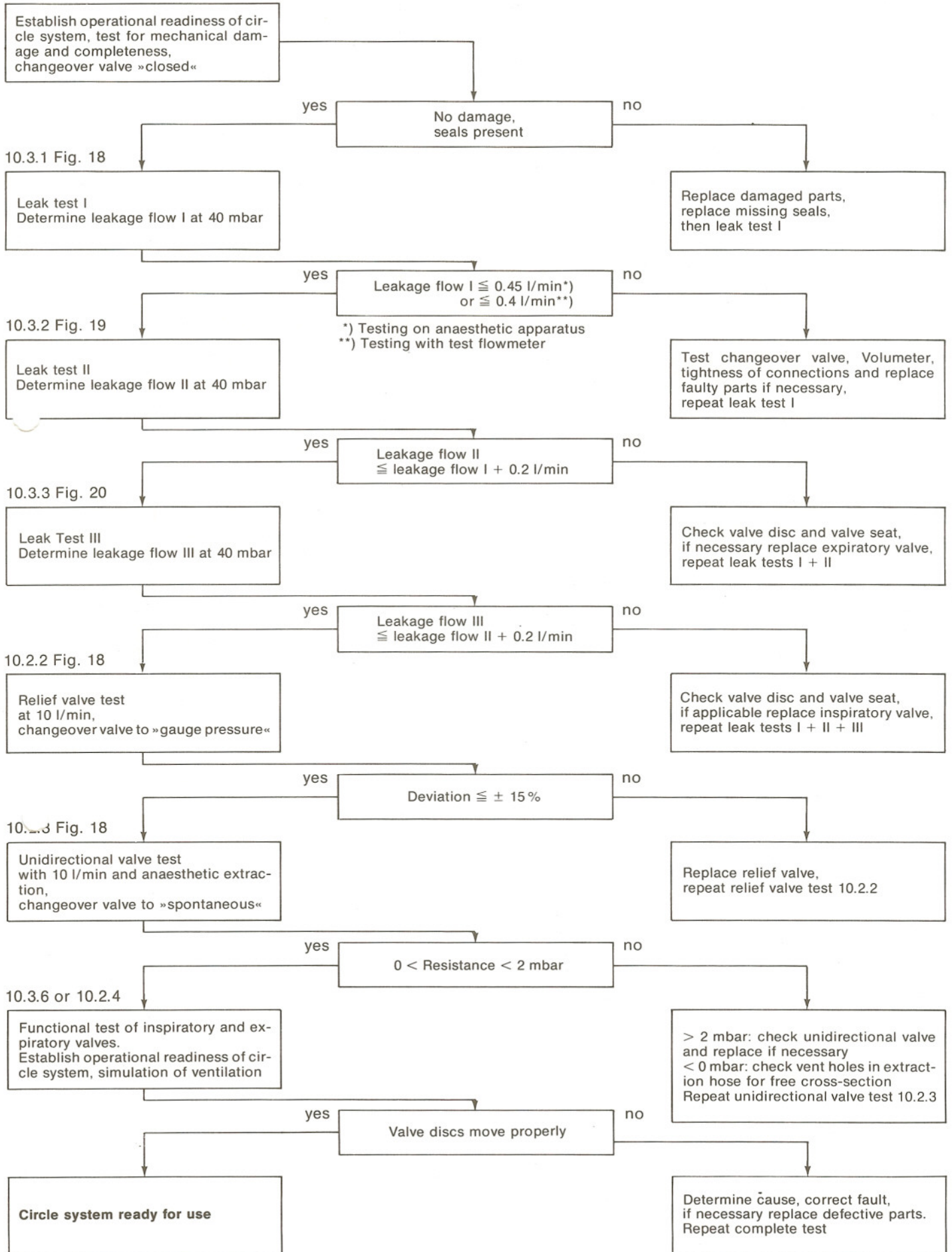

Fig. 19 Connection schematic for leak test II as per 10.3.2

Fig. 20 Connection schematic for leak test III as per 10.3.3

# 10.4 Test Chart

(Summary of Tests as per 10.2 and 10.3)



# 11 Maintenance, Inspection

To ensure that the circle system is always ready for use and fully operable, it is to be subjected to maintenance work by trained personnel at least once a year. We recommend concluding a maintenance agreement with the Technical Customer Service of Drägerwerk AG, which ensures thorough, regular testing with adjustment work and any necessary spare part replacement. In this respect, attention is drawn to the Section »Important Notice« on Page 2.

# 12 Parts List

No.	Designation	per set	Order Code	Designation
1–28	Circle system 7a	1	M 23074 M 25690	Circle system 7a
1–8	Circle system carrier	1	M 23023 M 24475	Circle system carrier
2	Clamping screw	2	M 22169	Set of clamping screws
3 4	Valve stem Cap screw	1 1	M 22170	Valve stem
5	Unidirectional valve	1	M 24271	Unidirectional valve
6 7	Lock nut Rubber disc	1 1	M 14198	Lock nut
8	Sealing ring	10	M 22154	Set of sealing rings
9	Sealing ring	5	M 22155	Set of sealing rings
10	Sight glass	5	M 22171	Set of sight glasses
11	Cap nut	2	M 22172	Set of cap nuts
12	Valve disc	4	M 19265	Set of valve discs
14 15	Ring Filter insert	1 1	M 22156	Set of filter inserts
6 7 9 10 11 12 14 15 16	Lock nut Rubber disc Sealing ring Sight glass Cap nut Valve disc Ring Filter insert Valve housing	1 1 1 1 1 1 1 1 1	M 19603 M 24469	Circle system inspiratory valve
9 10 11 12 13	Sealing ring Sight glass Cap nut Valve disc Valve housing	1 1 1 1 1	M 19617 M 24509	Circle system expiratory valve
18	Absorber jacket	2	M 22157	Set of absorber jackets
19	Sealing ring	4	M 22158	Set of sealing rings
21	Tightening nut	3	M 22159	Set of tightening nuts
22 23	Absorber base cap Absorber top cap	1 1	M 22160	Set of absorber caps
17 18 19 20 21 22 23	Absorber base Absorber jacket Sealing ring Cover, complete Tightening nut Absorber base cap Absorber top cap	1 1 2 1 3 1 1	M 13230	Absorber
24	Filler funnel	1	M 7700	Filler funnel
25	Corrugated hose	1	M 4147 M 25724	Corrugated hose
26	Ring	10	M 22161	Set of rings
27	Connection port	1	M 9177 M 25647	Connection port
28	Breathing bag 23–2.3	1	M 12963	Breathing bag 23–2.3

Items nos. preceded by symbol (▶) correspond to ISO standard

Subject to alterations

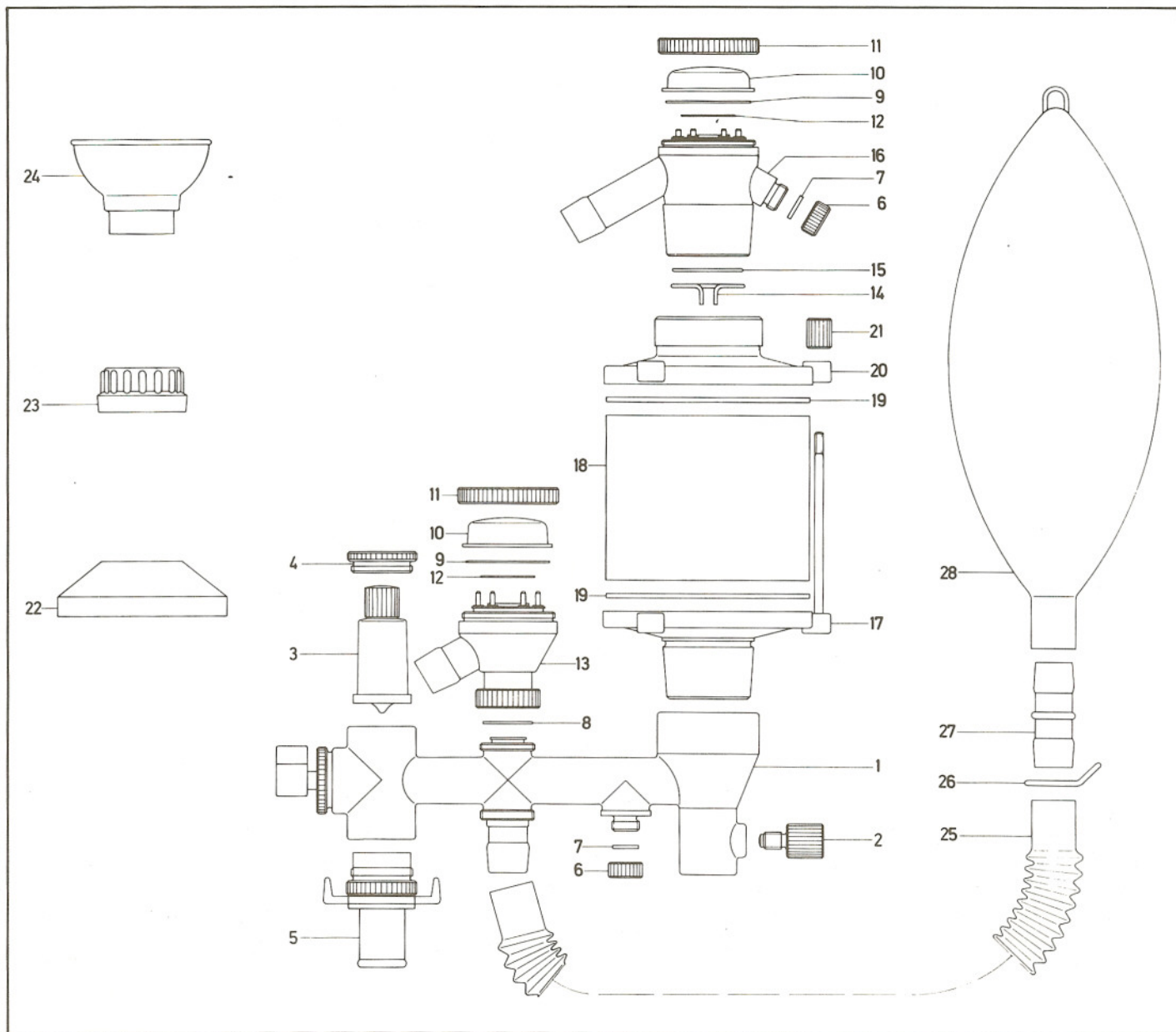

Fig. 21 Individual parts of circle system 7a (cf. Parts List)

37 849

**Note:** The item nos. in Fig. 21 (and in the Parts List) are not identical with the item nos. in Figs. 1–16.

## 13 Order List

Designation	Order Code
Circle system 7a	M 23074
Circle system 8 – ISO	► M 25690